

# FAR

BOLOGNA  
ITALY



S.r.l.



MADE IN ITALY

| Listino Prezzi | Price List | Liste de Prix | Preisliste | Lista de Precios | Cennik | Прейскурант





## Modalità d'impiego

INSTRUCTIONS FOR USE > MODE D'EMPLOI > BEDIENUNGSANWEISUNGEN > MODALIDAD DE EMPLEO  
ZASTOSOWANIE - SPOSÓB MONTAŻU > ИНСТРУКЦИИ ПО ИСПОЛЬЗОВАНИЮ

54



## Inserti filettati in acciaio

STEEL BLIND RIVET NUTS > INSERTS FILETÉS EN ACIER > STAHL BLINDNIETMUTTERN  
TUERCAS REMACHABLES EN ACERO  
NITONAKRĘTKI STALOWE > ВСТАВКИ С РЕЗЬБОЙ ИЗ СТАЛИ

57



## Inserti maschio in acciaio

STEEL BLIND RIVET BOLTS > GOUJONS À SERTIR EN ACIER > STAHL BLINDNIETSCHRAUBEN  
ESPARRAGOS REMACHABLES EN ACERO  
NITONAKRĘTKI ZE STALI NIERDZEWEJ > ВСТАВКИ С РЕЗЬБОЙ ИЗ НЕРЖАВЕЮЩЕЙ СТАЛИ

69



## Inserti filettati in acciaio inox

STAINLESS STEEL BLIND RIVET NUTS > INSERTS FILETÉS EN ACIER INOXYDABLE  
EDELSTAHL BLINDNIETMUTTERN > TUERCAS REMACHABLES EN ACERO INOXIDABLE  
NITOTAKRĘTKI ALUMINIOWE > ВСТАВКИ С РЕЗЬБОЙ ИЗ АЛЮМИНИЯ

72



## Inserti filettati in lega di alluminio

ALUMINIUM BLIND RIVET NUTS > INSERTS FILETÉS EN ALUMINIUM > ALU BLINDNIETMUTTERN  
TUERCAS REMACHABLES EN ALUMINIO  
NITOTAKRĘTKI ALUMINIOWE > ВСТАВКИ С РЕЗЬБОЙ ИЗ АЛЮМИНИЯ

81



## Inserti filettati speciali

THE SPECIAL BLIND RIVET NUTS > LES INSERTS FILETÉS SPÉCIAUX  
DIE SPEZIELLEN BLINDNIETMUTTERN > LAS TUERCAS REMACHABLES ESPECIALES  
NITONAKRĘTKI SPECJALNE > СПЕЦИАЛЬНЫЕ ВСТАВКИ С РЕЗЬБОЙ

84



## INSERTI FILETTATI

BLIND RIVET NUTS / INSERTS FILETÉS / BLINDNIETMUTTERN / TUERCAS REMACHABLES / NITONAKRĘTKI / ВСТАВКИ С РЕЗЬБОЙ

### > I MODALITÀ DI IMPIEGO

L'inserto filettato (o rivetto filettato) è un elemento di fissaggio che permette di collocare una filettatura su particolari aventi spessori molto ridotti o in posizioni disagiate, dove non sarebbe economico e/o possibile praticare una filettatura da utensile. Gli inserti filettati, oltre ad essere di pratica e rapida applicazione, offrono caratteristiche di resistenza molto elevate, siano questi costruiti in acciaio o in lega leggera. Disponibili con filettature metriche dal Ø M3 al Ø M12 in diversi formati, permettono di risolvere molti problemi sino ad ora affrontati con soluzioni dispendiose e certamente non affidabili tecnicamente. Interpellateci, siamo a vostra disposizione!

### > GB INSTRUCTIONS FOR USE

The blind rivet nuts (or nutsert) is a fastener that allows to thread on details with reduced thicknesses or located in uncomfortable places where it would not be economical and/or possible to make a thread by tool. Besides their simple and fast application the blind rivet nuts offer high resistance features either in steel or aluminium. Available in metrical threads from Ø M3 to Ø M12 and in different sizes, they can solve problems till now faced with expensive and unreaable solutions.

We are at your complete disposal for any further information. Consult us!

### > F MODE D'EMPLOI

L'insert fileté est un élément de fixation qui permet de placer un filetage sur des pièces qui ont des épaisseurs très réduites ou sur des positions incommodées où il n'est pas économique et/ou possible de faire un filetage d'outil. Les inserts filetés sont très pratiques et leur application est rapide; en outre ils offrent des caractéristiques de résistance très élevées aussi bien en acier qu'en alliage léger. Ils sont disponibles avec des filetages métriques de Ø M3 jusqu'au Ø M12 en plusieurs dimensions; ils permettent de résoudre beaucoup de problèmes qui ont été résolus jusqu'à maintenant par des solutions dispendieuses et pas sûres techniquement.

A votre disposition pour tous renseignements!

### > D BEDIENUNGSANWEISUNGEN

Die Blindnietmutter ist ein praktisches und einfaches Befestigungselement zum Anbringen eines Gewindes an sehr dünnwandigen Teilen sowie an Teilen, wo das maschinelle Gewindeschneiden unwirtschaftlich oder gar unmöglich ist. Hergestellt aus Stahl oder Aluminiumlegierung, mit metrischen Gewinden von Ø M3 bis Ø M12 in verschiedenen Grössen, sind die Blindnietmuttern sehr widerstandsfähig, und erlauben viele Probleme zu lösen, welche bis heute auf kostspielige und technisch nicht sehr zuverlässige Art bewältigt werden.

Fordern Sie uns an, wir beraten Sie gerne!

### > E MODALIDAD DE EMPLEO

La tuerca remachable es un elemento de fijación que permite colocar una fileteadura en espesores particularmente reducidos o en posiciones incomodas, sobre los cuales no sería económico y/o posible practicar un fileteado con herramienta. Las tuercas remachables, además de su práctica y rápida aplicación, ofrecen características de resistencia muy elevadas, sean estas construidas en acero o en aleación ligera. Disponibles con fileteaduras métricas desde el Ø M3 al Ø M12 en diversos formatos, permiten resolver muchos problemas que hasta ahora fueron solucionados de manera dispendiosa y técnicamente poco fiable.

Estamos a vuestra disposición para brindar toda la información necesaria.

### > PL ZASTOSOWANIE

Nitonakrętka jest elementem łącznym, pozwalającym na mocowanie gwintowane, w miejscach, które ze względu na małą grubość, trudny dostęp, lub nieopłacalność ekonomiczną, nie pozwalają na wykonanie tradycyjnego gwintowania z użyciem narzędzia.

Nitonakrętki, poza tym iż umożliwiają szybkie łączenie elementów, zapewniają bardzo wysokie parametry mechaniczne takiego połączenia, wykonane są ze stali lub lekkiego stopu.

Nitonakrętki dostępne są w zakresie średnic od M3 do M12 w różnych kształtach, umożliwiają rozwiązanie wielu problemów, które dotąd można było rozwiązać w sposób zależny od wielu czynników, lub technicznie zawodny. Jesteśmy do Państwa dyspozycji!

### > RUS ИНСТРУКЦИИ ПО ИСПОЛЬЗОВАНИЮ

Вставка с резьбой (или заклепка с резьбой) является элементом крепления, который позволяет вставку резьбы на детали очень узкой толщины или находящиеся в неудобной позиции, на которых невыгодно и/или невозможно реализовать резьбу резцом. Вставки с резьбой, кроме своего практичного и скорого применения, предоставляют высокие показатели выдержки, будь они из стали или из более легкого сплава. Детали доступные с метрической резьбой от Ø M3 до Ø M12 в разных форматах, позволяют решать проблемы прежде решаемые дорогими и непроверенными способами.

Мы остаемся в вашем распоряжении для дальнейшего сотрудничества. Обращайтесь к нам за советом!

**PRINCIPIO DI APPLICAZIONE**

APPLICATION PRINCIPLE

PRINCIPE D'APPLICATION

ANWENDUNGSPRINZIP

PRINCIPIO DE

SPOSÓB MC

ПРИНЦИП ИС

**LEGENDA**

SYMBOL LIST

LÉGENDE

LEGENDE

LEYENDA

LEGENDA

УСЛОВНЫЕ ЗНАКИ

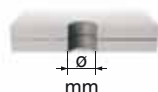
**Diametro del foro**

Hole diameter

Perçage

Bohrungsdurchmesser

Diámetro del orificio

Średnica otworu

Диаметр отверстия

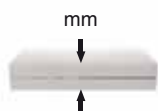
**Spessori serrabili minimi e massimi**

Grip range

Épaisseurs à serrer min. et max.

Min. und max. Schliessdicke

Espesores a remachar mín. y máx.

Zakres łączonych grubości

Максимальная и минимальная толщина зажатия

**Forza max. serraggio in Kgm (Nm)**

Max. clamping force Kgm (Nm)

Force de serrage max. Kgm (Nm)

Max. Klemmkraft Kgm (Nm)

Fuerza máx. de ajuste Kgm (Nm)

Maksymalny moment dokręcenia w Kgm (Nm)

Максимальная сила зажатия кгм (Nm)

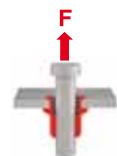
**Carico di rottura a trazione in kg (N)**

Tensile strength, kgs (N)

Charge de traction en kg (N)

Zugfestigkeit in Kg (N)

Carga de rotura por tracción en kg (N)

Wytrzymałość na rozciąganie w kg (N)

Предел прочности при тяге, в кг (N)

**I valori di resistenza a trazione sono riferiti ad un carico applicato come indicato dalla freccia apposta sul disegno.***The values of tensile strength refer to a load applied as indicated by the arrow placed on the drawing.**Les valeurs de résistance à la traction se réfèrent à une charge appliquée comme indiqué par la flèche présente sur le dessin.**Die Zugfestigkeitswerte beziehen sich auf eine durch den auf der Zeichnung eingetragenen Pfeil bezeichnete Belastung.**Los valores de resistencia a la tracción se refieren a una carga aplicada como indicado por la flecha puesta sobre el plano.**Wartości dotyczące wytrzymałości na rozciąganie odnoszą się do obciążenia zastosowanego w kierunku zgodnym ze wskazaniem strzałki.**Данные прочности при тяге указаны, в соответствии с тягой в направлении стрелки, на иллюстрации.*





## INSERTI FILETTATI IN ACCIAIO A TESTA CILINDRICA

STEEL BLIND RIVET NUTS CYLINDRICAL HEAD

INSERTS FILETÉS EN ACIER TÊTE CYLINDRIQUE

STAHL BLINDNIETMUTTERN - FLACHKOPF

TUERCAS REMACHABLES EN ACERO, CABEZA ANCHA

NITONAKRÛTKI STALOWE Z PŁASKIM KOŃCIEZEM

ВСТАВКИ С РЕЗЬБОЙ ИЗ СТАЛИ С ЦИЛИНДРИЧЕСКОЙ ГОЛОВКОЙ

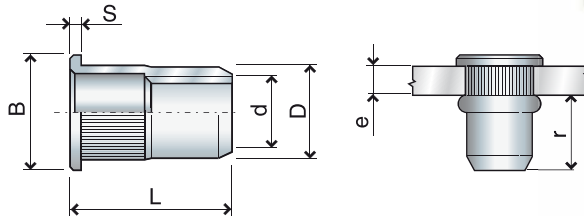

d	Tipo Type / Type Typ / Tipo Typ / Тип	e mm	r max	D	B	S	L	Cod. / Code Kode / Código Kod / Код	€ x 1000	N° Pz. N° pcs / N° pcs Stk Nr. / N° pzs. Ilość szt. Кол-во шт.	Cod. / Code Kode / Código Kod / Код	€ x 1000	N° Pz. N° pcs / N° pcs Stk Nr. / N° pzs. Ilość szt. Кол-во шт.
M3	FTT/C * M3 FTT/L	0,3÷1,8 1,8÷3	6	5	4,9	7	0,8 10,5	60203102 60203302	61,50	200	60203101 60203301	47,20	2.500
M4	FTT/C M4 FTT/L	0,3÷2,5 2,5÷4	7,5	6	5,9	9	1 13	60204102 60204302	68,00	200	60204101 60204301	52,00	2.500
M5	FTT/C M5 FTT/L	0,5÷3 3÷5	9,1	7	6,9	10	1,2 15,5	60205102 60205302	77,50	200	60205101 60205301	55,00	2.500
M6	FTT/C M6 FTT/L	0,5÷3 3÷5,5	10	9	8,9	12	1,5 17,5	60206102 60206302	101,50	200	60206101 60206301	70,00	2.500
M8	FTT/C M8 FTT/L	0,8÷3,5 3,5÷6	11,4	11	10,9	15	1,5 20	60208102 60208302	137,00	200	60208101 60208301	82,00	2.500
M10	FTT/C * M10 FTT/L	1÷3,5 3,5÷6	13	12	11,9	16	1,7 19 22	60210102 60210302	168,00	200	60210101 60210301	108,00	2.000
M10	FTT/C M10 FTT/L	1÷3,5 3,5÷6	14,5	13	12,9	17	1,7 21 24	60210402 60210502	187,00	200	60210401 60210501	120,00	2.000
M12	FTT/C * M12 FTT/L	1÷3,5 3,5÷6	16	15	14,9	20	2 22 25	60212102 60212302	360,00	100	60212101 60212301	235,00	1.000
M12	FTT/C * M12 FTT/L	1÷4 4÷7	19,5	16	15,9	23	2 27 30	60212602 60212702	405,00	100	60212601 60212701	280,00	1.000

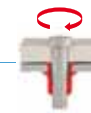

	d	D	Kg	N	Kgm	Nm
<b>Materiale</b>	M 3 *		438	4.300	0,1	1
Material	M 4		744	7.300	0,4	4
Matériel	M 5		1.167	11.450	0,7	7
Werkstoff	M 6		1.723	16.900	1,4	14
Material	M 8		2.467	24.200	2,4	24
Matériel	M 10 *	11,9	2.920	28.650	4	40
Material	M 10	12,9	3.160	31.000	4,2	42
Matériel	M 12 *	14,9	3.639	35.700	7	70
Material	M 12 *	15,9	4.842	47.500	7,6	76



**INSERTI FILETTATI IN ACCIAIO A TESTA SVASATA**

STEEL BLIND RIVET NUTS COUNTERSUNK HEAD

INSERTS FILETÉS EN ACIER TÊTE FRAISÉE

STAHL BLINDNIETMUTTERN - SENKKOPF

TUERCAS REMACHABLES EN ACERO, CABEZA AVELLANADA

NITONAKRÊTKI STALOWE Z KOENIERZEM STO<sup>o</sup> KOWYM

ВСТАВКИ С РЕЗЬБОЙ ИЗ СТАЛИ С РАСКЛЕШЕННОЙ ГОЛОВКОЙ

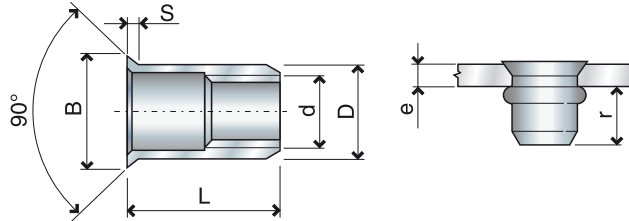

d	Tipo Type / Type Typ / Tipo Typ / Тип	e mm	r max	D	B	S	L	Cod. / Code Kode / Código Kod / Код	€	N° Pz. N° pcs / N° pcs Stk Nc. / N° pzs. Ilość szt. Кол-во шт.	Cod. / Code Kode / Código Kod / Код	€	N° Pz. N° pcs / N° pcs Stk Nc. / N° pzs. Ilość szt. Кол-во шт.
									x 1000			x 1000	
M3	FTS/C M3 FTS/L	1,5÷2,8 2,8÷4	6,2	5	4,9	8	1,5 9,5 10,5	60403102 60403302	61,50	200	60403101 60403301	47,20	2.500
M4	FTS/C M4 FTS/L	1,5÷3,5 3,5÷5	7,3	6	5,9	9	1,5 11 13	60404102 60404302	68,00	200	60404101 60404301	52,00	2.500
M5	FTS/C M5 FTS/L	1,5÷3,8 3,8÷6	8,4	7	6,9	10	1,5 13 15	60405102 60405302	77,50	200	60405101 60405301	55,00	2.500
M6	FTS/C M6 FTS/L	1,5÷3,8 3,8÷6	10	9	8,9	12	1,5 15 17	60406102 60406302	101,50	200	60406101 60406301	70,00	2.500
M8	FTS/C M8 FTS/L	1,5÷3,8 3,8÷6	11,3	11	10,9	14	1,5 16,5 19	60408102 60408302	137,00	200	60408101 60408301	82,00	2.500
M10	FTS/C M10 FTS/L	1,5÷3,8 3,8÷6	13	12	11,9	15	1,5 18 20,5	60410102 60410302	168,00	200	60410101 60410301	108,00	2.000

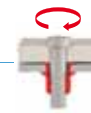

	d	Kg	N	Kgm	Nm
<b>Materiale</b> Material Matériel Werkstoff Material Material Материал	M 3	438	4.300	0,1	1
	M 4	744	7.300	0,4	4
	M 5	1.167	11.450	0,7	7
<b>Acciaio</b> Steel Acier Stahl Acero Stal Сталь	M 6	1.723	16.900	1,4	14
	M 8	2.467	24.200	2,4	24
	<b>C 4 C / C 10 C</b>	M 10	2.920	28.650	4





# FTR

## INSERTI FILETTATI IN ACCIAIO A TESTA RIDOTTA

STEEL BLIND RIVET NUTS REDUCED HEAD

INSERTS FILETÉS EN ACIER TÊTE RÉDUITE

STAHL BLINDNIETMUTTERN - KLEINKOPF

TUERCAS REMACHABLES EN ACERO, CABEZA REDUCIDA

NITONAKRĚTKI STALOWE Z MINI-KOENIERZEM

ВСТАВКИ С РЕЗЬБОЙ ИЗ СТАЛИ С СУЖЕННОЙ ГОЛОВКОЙ

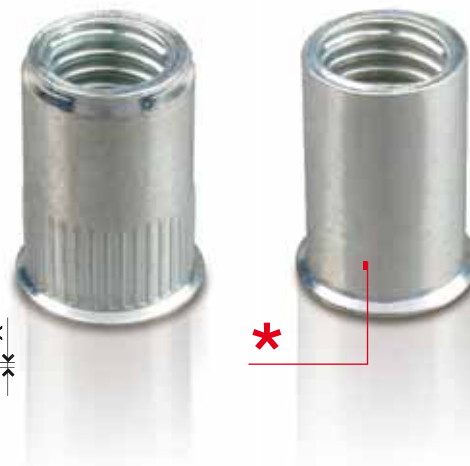
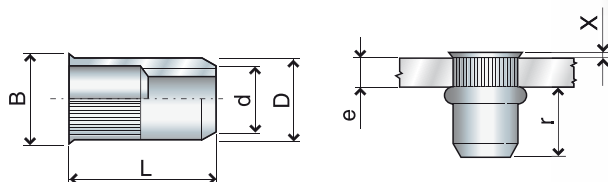

d	Tipo Type / Type Typ / Tipo Typ / Тип	e mm	r max	D	B	X	L	Cod. / Code Code / Código Cod / Код	€ x 1000	N° Pz. N° pcs / N° pcs Stk Nr. / N° pzs. Ilość szt. Кол-во шт.	Cod. / Code Code / Código Cod / Код	€ x 1000	N° Pz. N° pcs / N° pcs Stk Nr. / N° pzs. Ilość szt. Кол-во шт.	
M3	FTR/C*	0,5÷1,5	6,7	5	4,9	5,5	0,3	8,5	60503102	61,50	200	60503101	47,20	2.500
M4	FTR/C	0,5÷1,5	8	6	5,9	6,75	0,4	10	60504102	68,00	200	60504101	52,00	2.500
M4	FTR/L	1,5÷2,5						11	60504302			60504301		
M5	FTR/C	0,5÷2	9,6	7	6,9	8	0,4	12	60505102	77,50	200	60505101	55,00	2.500
M5	FTR/L	2÷3,5						13,5	60505302			60505301		
M6	FTR/C	0,5÷2	10,7	9	8,9	10	0,5	13,5	60506102	101,50	200	60506101	70,00	2.500
M6	FTR/L	2÷3,5						15	60506302			60506301		
M8	FTR/C	1÷2,5	12,4	11	10,9	12	0,5	16,5	60508102	137,00	200	60508101	82,00	2.500
M8	FTR/L	2,5÷4						18	60508302			60508301		
M10	FTR/C*	1÷2,5	14	12	11,9	13,5	0,8	18	60510102	168,00	200	60510101	108,00	2.000
M10	FTR/L*	2,5÷4						19,5	60510302			60510301		
M12	FTR/C*	1÷3,5	15,5	15	14,9	17	0,8	21	60512102	360,00	100	60512101	235,00	1.000

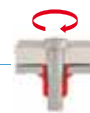
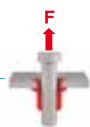

	d	Kg	N	Kgm	Nm
<b>Materiale</b> Material Matériel Werkstoff Material Material Материал	M 3 *	438	4.300	0,1	1
	M 4	744	7.300	0,4	4
	M 5	1.167	11.450	0,7	7
<b>Acciaio</b> Steel Acier Stahl Acero Stal Сталь	M 6	1.723	16.900	1,4	14
	M 8	2.467	24.200	2,4	24
	M 10 *	2.920	28.650	4	40
<b>C 4 C / C 10 C</b>	M 12 *	3.639	35.700	7	70

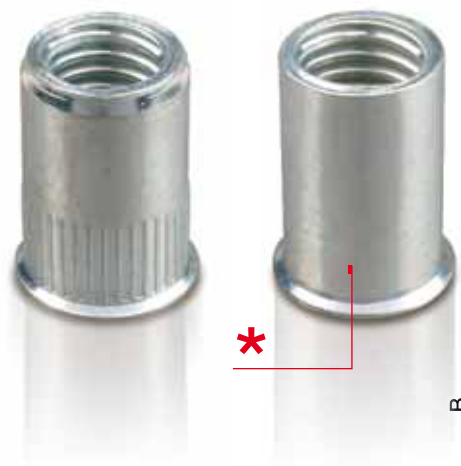

**INSERTI FILETTATI IN ACCIAIO A TESTA RIDOTTA**

STEEL BLIND RIVET NUTS REDUCED HEAD

INSERTS FILETÉS EN ACIER TÊTE RÉDUITE

STAHL BLINDNIETMUTTERN - KLEINKOPF

TUERCAS REMACHABLES EN ACERO, CABEZA REDUCIDA

NITONAKRĘTKI STALOWE Z MINI-KOENIERZEM

ВСТАВКИ С РЕЗЬБОЙ ИЗ СТАЛИ С СУЖЕННОЙ ГОЛОВКОЙ

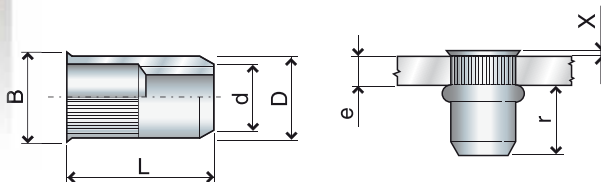

d	Tipo Type / Type Typ / Tipo Typ / Тип	e mm	r max	$\pm 0.1$ mm	D	B	X	L	Cod. / Code Kode / Código Kod / Код	€ x 1000	N° Pz. N° pcs / N° pces Stk Nr. / N° pzs. Ilość szt. Кол-во шт.	Cod. / Code Kode / Código Kod / Код	€ x 1000	N° Pz. N° pcs / N° pces Stk Nr. / N° pzs. Ilość szt. Кол-во шт.
M3	PR *	0,5÷1,5	6,7	4,8	4,7	5,3	0,3	9	60603002	61,50	200	60603001	47,20	2.500
M4	PR	0,5÷1,5	8	6,4	6,3	6,9	0,4	10,5	60604002	68,00	200	60604001	52,00	2.500
M5	PR	0,5÷2	9,1	7,2	7,1	7,7	0,4	12	60605002	77,50	200	60605001	55,00	2.500
M6	PR	0,7÷2,5	10,6	9,6	9,5	10,2	0,5	14	60606002	101,50	200	60606001	70,00	2.500
M8	PR	1÷3	11,6	10,6	10,5	11,3	0,5	16	60608002	137,00	200	60608001	82,00	2.500

- > Differiscono dal modello FTR nella dimensione del diametro esterno
- > They differ from the FTR model in the outside diameter dimension
- > Ils diffèrent du modèle FTR par la dimension du diamètre extérieur
- > Sie weichen von dem Typ FTR in der Außendurchmesserabmessung ab
- > Se difieren del modelo FTR en la dimensión del diámetro exterior
- > Nitonakrętki PR różnią się od nitonakrętek FTR średnicą zewnętrzną
- > Отличаются от образца FTR размером внешнего диаметра

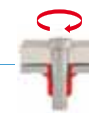
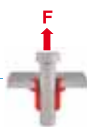

	d	Kg	N	Kgm	Nm
<b>Materiale</b> Material Matériel Werkstoff Material Material Материал	M 3 *	387	3.800	0,1	1
	M 4	663	6.500	0,4	4
<b>Acciaio</b> Steel Acier Stahl Acero Stal Сталь	M 5	1.223	12.000	0,7	7
	M 6	1.636	16.050	1,4	14
<b>C 4 C / C 10 C</b>	M 8	2.090	20.500	2,4	24



## INSERTI FILETTATI CIECHI IN ACCIAIO A TESTA CILINDRICA

STEEL BLIND RIVET NUTS CYLINDRICAL HEAD - CLOSED END TYPE

INSERTS FILETÉS AVEUGLES EN ACIER TÊTE CYLINDRIQUE

STAHL BLINDNIETMUTTERN - FLACHKOPF - RUNDSCHAFT GESCHLOSSEN

TUERCAS REMACHABLES CIEGAS EN ACERO, CABEZA ANCHA

NIŃONAKRÉTKI STALOWE ZAŁĘPIONE Z PEASKIM KOŁNIERZEM

ГЛУХИЕ ВСТАВКИ С РЕЗЬБОЙ ИЗ СТАЛИ С ЦИЛИНРИЧЕСКОЙ ГОЛОВКОЙ

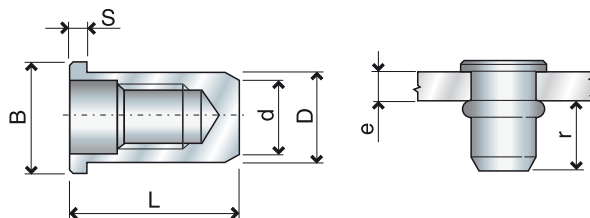

d	Tipo Type / Type Typ / Tipo Typ / Тип	e mm	r max	D	B	S	L	Cod. / Code Kode / Código Kod / Код	€	N° Pz. N° pcs / N° pces Stk Nr. / N° pzs. Ilość szt. Кол-во шт.	Cod. / Code Kode / Código Kod / Код	€	N° Pz. N° pcs / N° pces Stk Nr. / N° pzs. Ilość szt. Кол-во шт.	
									x 1000			x 1000		
M3	FTTC/C	0,3÷1,8	11	5	4,9	7	0,8	14,5	60803102	100,00	200	60803101	75,00	2.500
M3	FTTC/L	1,8÷3					15,5	60803302			60803301			
M4	FTTC/C	0,3÷2,5	12,8	6	5,9	9	1	16,5	60804102	115,00	200	60804101	85,50	2.500
M5	FTTC/C	0,5÷3	14	7	6,9	10	1,2	18	60805102	132,60	200	60805101	90,00	2.500
M5	FTTC/L	3÷5					20,5	60805302			60805301			
M6	FTTC/C	0,5÷3	15,5	9	8,9	12	1,5	20,5	60806102	161,00	200	60806101	110,00	2.500
M8	FTTC/C	0,8÷3,5	19,3	11	10,9	15	1,5	25,5	60808102	211,50	200	60808101	132,50	2.000
M8	FTTC/L	3,5÷6					28	60808302			60808301			
M10	FTTC/C	1÷3,5	23	12	11,9	16	1,7	29	60810102	265,00	200	60810101	170,00	1.000

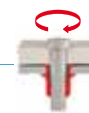

	d	Kg	N	Kgm	Nm
<b>Materiale</b>	M 3	438	4.300	0,1	1
<i>Material</i>					
<i>Matériel</i>	M 4	744	7.300	0,4	4
<i>Werkstoff</i>					
<i>Material</i>	M 5	1.167	11.450	0,7	7
<i>Material</i>					
<i>Материал</i>	M 6	1.723	16.900	1,4	14
<b>Acciaio</b>					
<i>Steel</i>	M 8	2.467	24.200	2,4	24
<i>Acier</i>					
<i>Stahl</i>					
<i>Acero</i>					
<i>Stal</i>					
<i>Сталь</i>					
<b>C 4 C / C 10 C</b>	M 10	2.920	28.650	4	40



**INSERTI FILETTATI IN ACCIAIO A TESTA CILINDRICA GAMBO ESAGONALE**

STEEL BLIND RIVET NUTS CYLINDRICAL HEAD HEXAGONAL SHANK

INSERTS FILETÉS EN ACIER TÊTE CYLINDRIQUE QUEUE HEXAGONALE

STAHL BLINDNIETMUTTERN - FLACHKOPF - SECHSKANTSCHAFT

TUERCAS REMACHABLES HEXAGONALES EN ACERO, CABEZA ANCHA

NITONAKRÊTKI STALOWE SZEŒCIOKŹTNE Z PEASKIM KOENIERZEM

ВСТАВКИ С РЕЗЬБОЙ ИЗ СТАЛИ С ЦИЛИНДРИЧЕСКОЙ ГОЛОВКОЙ И ШЕСТИУГОЛЬНЫМ СТЕРЖНЕМ

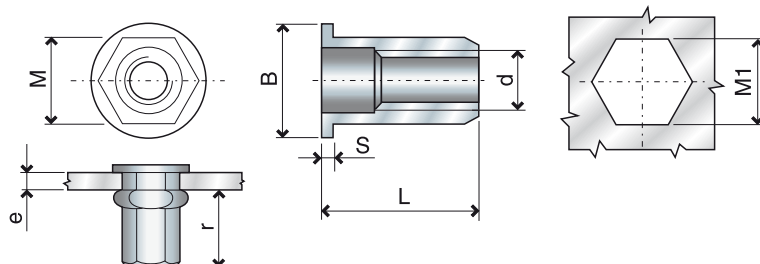

d	Tipo Type / Type Typ / Tipo Typ / Тип	e mm	r max	M1	M	B	S	L	Cod. / Code Kode / Código Kod / Код	€ x 1000	N° Pz. N° pcs / N° pces Stk Nr. / N° pzs. Ilość szt. Кол-во шт.	Cod. / Code Kode / Código Kod / Код	€ x 1000	N° Pz. N° pcs / N° pces Stk Nr. / N° pzs. Ilość szt. Кол-во шт.
M4	FTTE	0,5÷2	7,1	6	5,9	9	1	11	63104002	78,00	200	63104001	62,00	2.500
M5	FTTE	0,5÷3	9	7	6,9	10	1	14	63105002	89,00	200	63105001	66,00	2.500
M6	FTTE	0,5÷3	10,3	9	8,9	13	1,5	16	63106002	110,00	200	63106001	80,00	2.500
M8	FTTE	0,5÷3	11,8	11	10,9	16	1,5	18	63108002	140,00	200	63108001	105,00	2.500
M10	FTTE	0,5÷3	13,8	12,1	12	18	1,7	20	63110002	165,00	200	63110001	124,50	2.000
M10	FTTE	1÷3,5	15,5	13	12,9	19	2	23	63110702	187,00	200	63110701	140,00	1.000
M12	FTTE	1÷4	18,3	16	15,9	23	2	27	63112002	395,00	100	63112001	300,00	1.000

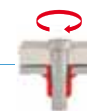

	d	M	Kg	N	Kgm	Nm
<b>Materiale</b> Material Matériel Werkstoff Material Material Материал  <b>Acciaio</b> Steel Acier Stahl Acero Stal Сталь  <b>C 4 C / C 10 C</b>	M 4		688	6.750	0,4	4
	M 5		1.269	12.450	0,7	7
	M 6		1.774	17.400	1,4	14
	M 8		2.569	25.200	2,4	24
	M10	12	3.109	30.500	4	40
	M10	12,9	4.220	41.400	4,2	42
M12		6.422	63.000	7,6	76	



## INSERTI FILETTATI CIECHI IN ACCIAIO A TESTA CILINDRICA GAMBO ESAGONALE

STEEL BLIND RIVET NUTS CYLINDRICAL HEAD HEXAGONAL SHANK - CLOSED END TYPE

INSERTS FILETÉS AVEUGLES EN ACIER TÊTE CYLINDRIQUE QUEUE HEXAGONALE

STAHL BLINDNIETMUTTERN - FLACHKOPF - SECHSKANTSCHAFT GESCHLOSSEN

TUERCAS REMACHABLES HEXAGONALES CIEGAS EN ACERO, CABEZA ANCHA

NITONAKRÊTKI STALOWE SZEŚCIOKĄTNE ZAŚLEPIONE Z PEŁSKIM KOŁNIERZEM

ГЛУХИЕ ВСТАВКИ С РЕЗЬБОЙ ИЗ СТАЛИ С ЦИЛИНДРИЧЕСКОЙ ГОЛОВКОЙ И ШЕСТИУГОЛЬНЫМ СТЕРЖНЕМ

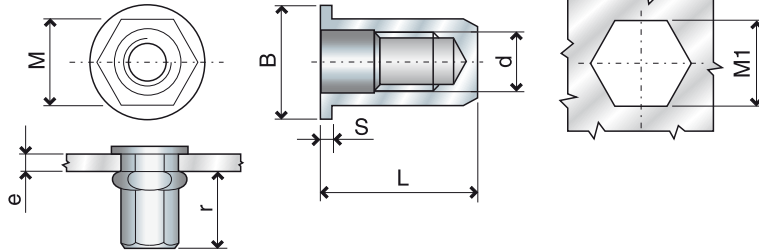

d	Tipo Type / Type Typ / Tipo Typ / Тип	e mm	r max	M1	M	B	S	L	Cod. / Code Kode / Código Kod / Код	€ x 1000	N° Pz. N° pcs / N° pces Stk Nr. / N° pzs. Ilość szt. Кол-во шт.	Cod. / Code Kode / Código Kod / Код	€ x 1000	N° Pz. N° pcs / N° pces Stk Nr. / N° pzs. Ilość szt. Кол-во шт.
M4	FTTEC	0,5÷2	12,1	6	5,90	9	1	16	63204002	121,50	200	63204001	98,00	2.500
M5	FTTEC	0,5÷3	14,8	7	6,90	10	1	20	63205002	145,00	200	63205001	105,00	2.500
M6	FTTEC	0,5÷3	16,3	9	8,90	13	1,5	22	63206002	180,00	200	63206001	130,00	2.500
M8	FTTEC	0,5÷3	19,8	11	10,9	16	1,5	26	63208002	230,00	200	63208001	155,00	1.000

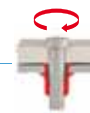

	d	Kg	N	Kgm	Nm
<b>Materiale</b> Material Matériel Werkstoff Material Материал	M 4	688	6.750	0,4	4
	M 5	1.269	12.450	0,7	7
<b>Acciaio</b> Steel Acier Stahl Acero Stal Сталь	M 6	1.774	17.400	1,4	14
<b>C 4 C / C 10 C</b>	M 8	2.569	25.200	2,4	24



**INSERTI FILETTATI IN ACCIAIO A TESTA RIDOTTA GAMBO PARZIALMENTE ESAGONALE**

STEEL BLIND RIVET NUTS REDUCED HEAD - HALF HEXAGONAL SHANK

INSERTS FILETÉS EN ACIER TÊTE RÉDUITE QUEUE EN PARTIE HEXAGONALE

STAHL BLINDNIETMUTTERN - KLEINKOPF - TEILSECHSKANTSCHAFT

TUERCAS REMACHABLES SEMIHEXAGONALES EN ACERO, CABEZA REDUCIDA

NIŁONAKRÉTKI STALOWE SZEŚCIOKĄTNE Z MINI-KOENIERZEM

ВСТАВКИ С РЕЗЬБОЙ ИЗ СТАЛИ С СУЖЕННОЙ ГОЛОВКОЙ И НЕПОЛНОСТЬЮ ШЕСТИУГОЛЬНЫМ СТЕРЖНЕМ

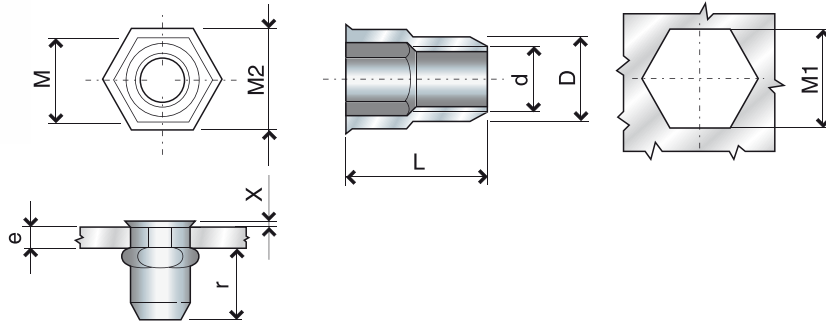

d	Tipo Type / Type Typ / Tipo Typ / Тип	e mm	r max	M1	M	M2	X	D	L	Cod. / Code Kode / Código Kod / Код	€	N° Pz. N° pcs / N° pcs Stk. Nr. / N° pzs. Ilość szt. Кол-во шт.	Cod. / Code Kode / Código Kod / Код	€	N° Pz. N° pcs / N° pcs Stk. Nr. / N° pzs. Ilość szt. Кол-во шт.
											x 1000			x 1000	
M4	FTRE	0,5÷2	7,8	6,4	6,3	7	0,4	6,3	10,4	63304002	75,00	200	63304001	59,00	2.500
M5	FTRE	0,5÷3	8,9	7,3	7,2	8,3	0,4	7,1	11,8	63305002	85,00	200	63305001	66,00	2.500
M6	FTRE	0,7÷3	11,3	9,7	9,6	10,2	0,5	9,5	14,6	63306002	105,00	200	63306001	79,00	2.500
M8	FTRE	0,9÷3,3	11,2	10,7	10,6	11,8	0,5	10,5	16	63308002	124,00	200	63308001	92,00	2.500

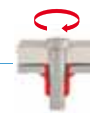

	d	Kg	N	Kgm	Nm
<b>Materiale</b> Material Matériel Werkstoff Material Material Материал	M 4	652	6.400	0,4	4
	M 5	892	8.750	0,7	7
<b>Acciaio</b> Steel Acier Stahl Acero Stal Сталь	M 6	1.213	11.900	1,4	14
<b>C 4 C / C 10 C</b>	M 8	1.335	13.100	2,4	24



## INSERTI FILETTATI IN ACCIAIO A TESTA RIDOTTA GAMBO ESAGONALE

STEEL BLIND RIVET NUTS REDUCED HEAD HEXAGONAL SHANK

INSERTS FILETÉS EN ACIER TÊTE RÉDUITE QUEUE HEXAGONALE

STAHL BLINDNIETMUTTERN - KLEINKOPF - SECHSKANTSCHAFT

TUERCAS REMACHABLES HEXAGONALES EN ACERO, CABEZA REDUCIDA

NITONAKRÊTKI STALOWE SZEŚCIOKĄTNE Z MINI-KOENIERZEM

ВСТАВКИ С РЕЗЬБОЙ ИЗ СТАЛИ С СУЖЕННОЙ ГЛОВКОЙ И ШЕСТИУГОЛЬНЫМ СТЕРЖНЕМ

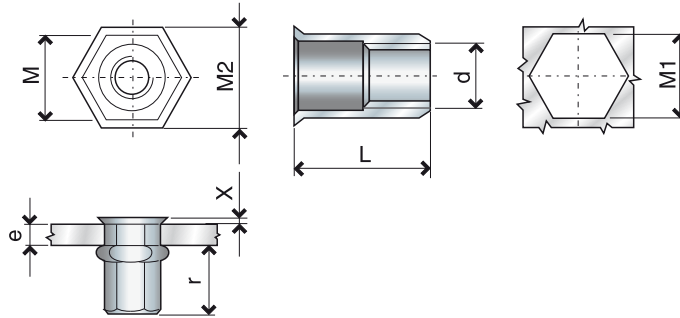

d	Tipo Type / Type Typ / Tipo Typ / Тип	e mm	r max	M1	M	M2	X	L	Cod. / Code Kode / Código Kod / Код	€	N° Pz. N° pcs / N° pcs Stk Nr. / N° pcs. Ilość szt. Кол-во шт.	Cod. / Code Kode / Código Kod / Код	€	N° Pz. N° pcs / N° pcs Stk Nr. / N° pcs. Ilość szt. Кол-во шт.
										x 1000			x 1000	
M4	ER	0,5÷2	7,6	6	5,9	6,6	0,4	11	63404002	75,00	200	63404001	59,00	2.500
M5	ER	0,5÷3	9,4	7	6,9	8	0,5	14	63405002	85,00	200	63405001	66,00	2.500
M6	ER	0,5÷3	11,3	9	8,9	10	0,5	16	63406002	105,00	200	63406001	79,00	2.500
M8	ER	0,5÷3	12,8	11	10,9	12	0,5	18	63408002	124,00	200	63408001	92,00	2.500
M10	ER	1÷3,5	16,3	12,1	12	13,5	0,7	23	63410002	140,00	200	63410001	100,00	2.000
M12	ER	1÷4	16,8	16	15,9	17,8	1	25	63412002	335,00	100	63412001	255,00	1.000

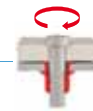

	d	Kg	N	Kgm	Nm
<b>Materiale</b>	M 4	688	6.750	0,4	4
<b>Material</b>	M 5	1.269	12.450	0,7	7
<b>Matériel</b>	M 6	1.774	17.400	1,4	14
<b>Werkstoff</b>	M 8	2.569	25.200	2,4	24
<b>Material</b>	M10	3.109	30.500	4	40
<b>Material</b>	M12	6.422	63.000	7,6	76
<b>Материал</b>					
<b>Acciaio</b>					
<b>Steel</b>					
<b>Acier</b>					
<b>Stahl</b>					
<b>Acero</b>					
<b>Stal</b>					
<b>Сталь</b>					
<b>C 4 C / C 10 C</b>					



**INSERTI FILETTATI CIECHI IN ACCIAIO A TESTA RIDOTTA GAMBO ESAGONALE**  
 STEEL BLIND RIVET NUTS REDUCED HEAD HEXAGONAL SHANK - CLOSED END TYPE  
 INSERTS FILETÉS AVEUGLES EN ACIER TÊTE RÉDUITE QUEUE HEXAGONALE  
 STAHL BLINDNIETMUTTERN - KLEINKOPF - SECHSKANTSCHAFT GESCHLOSSEN  
 TUERCAS REMACHABLES HEXAGONALES CIEGAS EN ACERO, CABEZA REDUCIDA  
 NITONAKRÊTKI STALOWE SZEŒCIOKŹTNE ZAŚLEPIONE Z MINI-KOENIERZEM  
 ГЛУХИЕ ВСТАВКИ С РЕЗЬБОЙ ИЗ СТАЛИ С СУЖЕННОЙ ГЛОВКОЙ И ШЕСТИУГОЛЬНЫМ СТЕРЖНЕМ

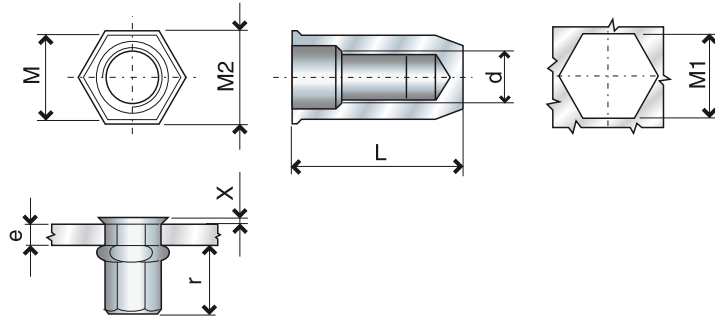

d	Tipo Type / Type Typ / Tipo Typ / Тип	e mm	r max	M1	M	M2	X	L	Cod. / Code Kode / Código Kod / Код	€	N° Pz. N° pcs / N° pces Stk Nr. / N° pzs. Ilość szt. Кол-во шт.	Cod. / Code Kode / Código Kod / Код	€	N° Pz. N° pcs / N° pces Stk Nr. / N° pzs. Ilość szt. Кол-во шт.
										x 1000			x 1000	
M4	ERC	0,5÷2	12,6	6	5,9	6,6	0,4	16	63504002	100,00	200	63504001	87,00	2.500
M5	ERC	0,5÷3	15,4	7	6,9	8	0,5	20	63505002	120,00	200	63505001	105,00	2.500
M6	ERC	0,5÷3	17,3	9	8,9	10	0,5	22	63506002	152,00	200	63506001	120,00	2.500
M8	ERC	0,5÷3	20,8	11	10,9	12	0,5	26	63508002	215,00	200	63508001	167,00	2.000

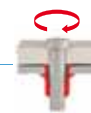

	d	Kg	N	Kgm	Nm
<b>Materiale</b> Material Matériel Werkstoff Material Материал	M 4	688	6.750	0,4	4
	M 5	1.269	12.450	0,7	7
<b>Acciaio</b> Steel Acier Stahl Acero Stal Сталь	M 6	1.774	17.400	1,4	14
<b>C 4 C / C 10 C</b>	M 8	2.569	25.200	2,4	24



**INSERTI FILETTATI ACCIAIO A TESTA RIDOTTA GAMBO PARZIALMENTE ESAGONALE**

STEEL BLIND RIVET NUTS REDUCED HEAD - HALF HEXAGONAL SHANK

INSERTS FILETÉS EN ACIER TÊTE RÉDUITE QUEUE EN PARTIE HEXAGONALE

STAHL BLINDNIETMUTTERN - KLEINKOPF - TEILSECHSKANTSCHAFT

TUERCAS REMACHABLES SEMIHEXAGONALES EN ACERO, CABEZA REDUCIDA

NITONAKRĘTKI STALOWE SZEŚCIOKĄTNE Z MINI-KOENIERZEM

ВСТАВКИ С РЕЗЬБОЙ ИЗ СТАЛИ С СУЖЕННОЙ ГЛОВКОЙ И НЕПОЛНОСТЬЮ ШЕСТИУГОЛЬНЫМ СТЕРЖНЕМ

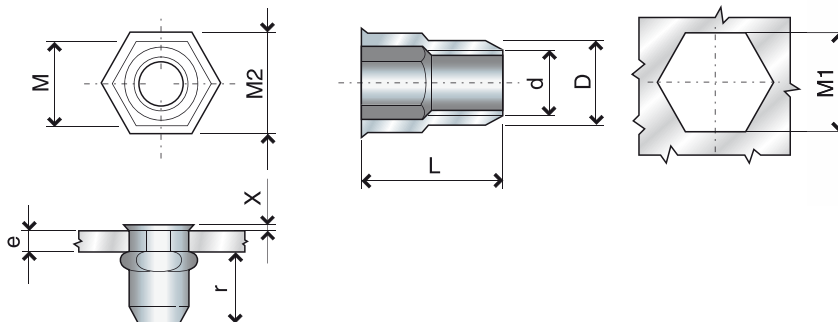

d	Typo Type / Type Typ / Tipo Typ / Тип	e mm	r max	M1	M	M2	X	D	L	Cod. / Code Kode / Código Kod / Код	€ x 1000	N° Pz. N° pcs / N° pcs Stk Nr. / N° pzs. Ilość szt. Кол-во шт.	Cod. / Code Kode / Código Kod / Код	€ x 1000	N° Pz. N° pcs / N° pcs Stk Nr. / N° pzs. Ilość szt. Кол-во шт.
M4	IE	0,5÷2	8	6	5,9	6,8	0,4	5,9	10,6	62004002	75,00	200	62004001	59,00	2.500
M5	IE	0,5÷3	8	7	6,9	8	0,4	6,9	11,6	62005002	85,00	200	62005001	66,00	2.500
M6	IE	0,5÷3	10,6	9	8,9	10	0,5	8,9	14,5	62006002	105,00	200	62006001	79,00	2.500
M8	IE	0,8÷3	11	11	10,9	12	0,5	10,9	15,8	62008002	124,00	200	62008001	92,00	2.500

- > Differiscono dal modello FTRE nella dimensione dell'esagono
- > They differ from the FTRE model in the hexagon dimension
- > Ils différent du modèle FTRE par la dimension de l'hexagone
- > Sie weichen von dem Typ FTRE in der Sechskantabmessung ab
- > Se difieren del modelo FTRE en la dimensión del hexágono
- > Nitonakrętki IE różnią się od nitonakrętek FTRE wymiarami sześciokąta
- > Отличается от образца FTRE размером внешнего диаметра

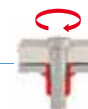

	d	Kg	N	Kgm	Nm
<b>Materiale</b> Material Matériel Werkstoff Material Material Материал	M 4	663	6.500	0,4	4
<b>Acciaio</b> Steel Acier Stahl Acero Stal Сталь	M 5	815	8.000	0,7	7
	M 6	1.223	12.000	1,4	14
<b>C 4 C / C 10 C</b>	M 8	2.263	22.200	2,4	24



## INSERTI FILETTATI IN ACCIAIO A TESTA CILINDRICA GAMBO PARZIALMENTE ESAGONALE

STEEL BLIND RIVET NUTS CYLINDRICAL HEAD - HALF HEXAGONAL SHANK

INSERTS FILETÉS EN ACIER TÊTE CYLINDRIQUE QUEUE EN PARTIE HEXAGONALE

STAHL BLINDNIETMUTTERN - FLACHKOPF - TEILSECHSKANTSCHAFT

TUERCAS REMACHABLES SEMIHEXAGONALES EN ACERO, CABEZA ANCHA

NITONAKRÊTKI STALOWE SZEŚCIOKĄTNE Z PEASKIM KOŃCERZEM

ВСТАВКИ С РЕЗЬБОЙ ИЗ СТАЛИ С ЦИЛИНДРИЧЕСКОЙ ГЛОВКОЙ И НЕПОЛНОСТЬЮ ШЕСТИУГОЛЬНЫМ СТЕРЖНЕМ

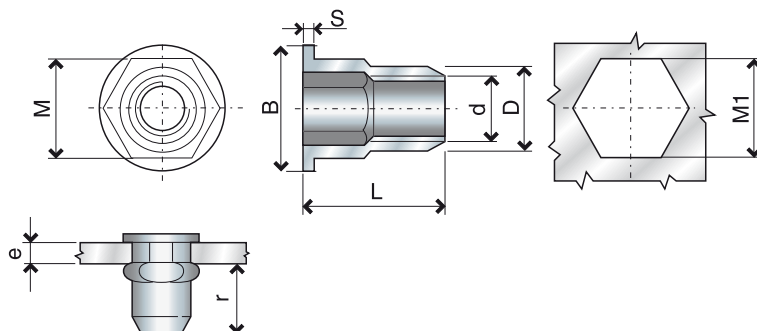

d	Типо Type / Type Typ / Tipo Typ / Тип	e mm	r max	M1	M	B	S	L	Cod. / Code Kode / Código Kod / Код	€ x 1000	N° Pz. N° pcs / N° pces Štk Nr. / N° pzs. Ilość szt. Кол-во шт.
M4	FTTSE	0,5÷2	7,1	6	5,9	9	1	11	62804001	62,00	2.500
M5	FTTSE	0,5÷3	9	7	6,9	10	1	14	62805001	66,00	2.500
M6	FTTSE	0,5÷3	10,3	9	8,9	13	1,5	16	62806001	80,00	2.500
M8	FTTSE	0,5÷3	11,8	11	10,9	16	1,5	18	62808001	105,00	2.500
M10	FTTSE	1÷3,5	15,5	13	12,9	19	2	23	62810001	140,00	1.000

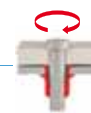

	d	Kg	N	Kgm	Nm
<b>Materiale</b> Material Matériel Werkstoff Material Material Материал	M 4	668	6.550	0,4	4
	M 5	1.147	11.250	0,7	7
<b>Acciaio</b> Steel Acier Stahl Acero Stal Сталь	M 6	1.753	17.200	1,4	14
	M 8	2.436	23.900	2,4	24
<b>C 4 C / C 10 C</b>	M 10	3.486	34.200	4,2	42



# CM

## INSERTI MASCHIO IN ACCIAIO

STEEL BLIND RIVET BOLTS

GOUJONS À SERTIR EN ACIER

STAHL BLINDNIETSCHRAUBEN

ESPARRAGOS REMACHABLES EN ACERO

NITOTRZPIENIE STALOWE Z GWINTEM ZEWNĘTRZNYM

СТАЛЬНЫЕ ВСТАВКИ МЕТЧИКИ

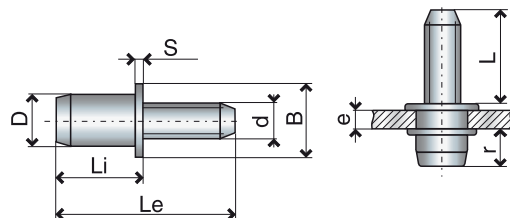

d	Типо Type / Type Typ / Tipo Typ / Тип	e mm	r max	D	B	S	L min	Li	Le	Cod. / Code Kode / Código Kod / Код	€ x 1000	N° Pz. N° pcs / N° pcs Stk Nr. / N° pzs. Ilość szt. Кол-во шт.
M5	CM/C	0,5÷3	7,0	7	6,9	1	15	12	25	63805103	165,00	500
M5	CM/M						20	30	63805203			
M5	CM/L						25	35	63805303			
M6	CM/C	0,5÷3	9,0	9	8,9	1,5	15	14,5	27	63806103	198,00	500
M6	CM/M						20	32	63806203			
M6	CM/L						25	37	63806303			
M8	CM/C	0,5÷3	10	11	10,9	1,5	20	15,5	33	63808103	265,00	500
M8	CM/L						25	38	63808303			



	d	Kg	N	Kgm	Nm
<b>Materiale</b> Material Matériel Werkstoff Material Material Материал	M 5	714	7.000	0,7	7
<b>Acciaio</b> Steel Acier Stahl Acero Stal Сталь	M 6	1.019	10.000	1,0	10
	M 8	2.854	28.000	3,1	30



**INSERTI MASCHIO A GAMBO ESAGONALE IN ACCIAIO**

STEEL BLIND RIVET BOLTS · HEXAGONAL SHANK

GOUJONS À SERTIR EN ACIER QUEUE HEXAGONALE

STAHL BLINDNIETSCHRAUBEN · SECHSKANTSCHAFT

ESPARRAGOS REMACHABLES EN ACERO CON CUERPO HEXAGONAL

NITOTRZPIENIE STALOWE SZEŚCIOKĄTNE Z GWINTEM ZEWNĘTRZNYM

СТАЛЬНЫЕ ВСТАВКИ МЕТЧИКИ С ШЕСТИУГОЛЬНЫМ СТЕРЖНЕМ

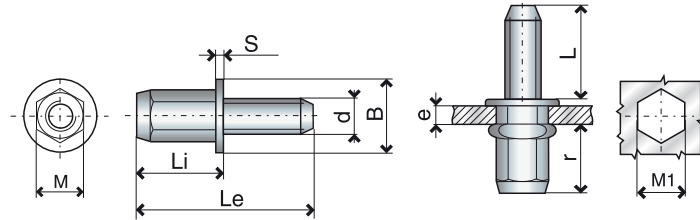

d	Tipo Type / Type Typ / Tipo Typ / Тип	e mm	r max	M1	M	B	S	L min	Li	Le	Cod. / Code Kode / Código Kod / Код	€ x 1000	N° Pz. N° pcs / N° pcs Stk Nr. / N° pzs. Ilość szt. Кол-во шт.
M5	EM/C	0,5÷3	6	7	6,9	10	1	15	12	25	64005103	185,00	500
	EM/M							20		30	64005203		
	EM/L							25		35	64005303		
M6	EM/C	0,5÷3	8	9	8,9	13	1,5	15	14,5	27	64006103	225,00	500
	EM/M							20		32	64006203		
	EM/L							25		37	64006303		
M8	EM/C	0,5÷3	9	11	10,9	16	1,5	20	15,5	33	64008103	310,00	500
	EM/M							25		38	64008303		
	EM/L												

	d	Kg	N	Kgm	Nm
<b>Materiale</b> Material Matériel Werkstoff Material Material Материал  <b>Acciaio</b> Steel Acier Stahl Acero Stal Сталь	M 5	714	7.000	0,7	7
	M 6	1.019	10.000	1,0	10
	M 8	2.854	28.000	3,1	30



## PRINCIPIO DI APPLICAZIONE

APPLICATION PRINCIPLE

PRINCIPE D'APPLICATION

ANWENDUNGSPRINZIP

PRINCIPIO DE APLICACIÓN

SPOSÓB MOCOWANIA NITOTRZPIENI

ПРИНЦИП УСТАНОВКИ

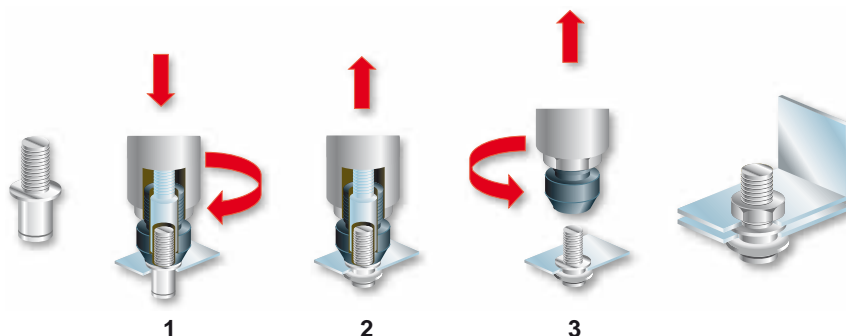

**Tirante per inserti maschio**

**Tie-rod for blind rivet bolts**

**Tirant pour goujons à sertir**

**Gewindedorn für Blindnietsschrauben**

**Tirante para esparragos remachables**

**Zestaw do nitotrzpieni**

**Набор расчалок для вставок входящих**

**внутрь**

- Ciascun tirante è abbinato alla relativa testina già in dotazione.
- Each tie-rod is coupled with the relevant head included in the kit.
- Chaque tirant a sa tête assortie fournie avec l'outil de pose.
- Jeder Gewindedorn ist mit dem entsprechenden Mundstück bei Werkzeugausrüstung zu verwenden.
- Cada tirante es acoplado a la cabeza correspondiente ya en el equipamiento base.
- Każdy trzpień gwintujący pracuje z odpowiednią głowicą z wyposażenia nitownicy.
- Каждая расчалка сопровождается подходящей головкой(входящей в набор).



## KJ 45 - KJ 45/S

Codice / Code  
Kode / Código  
Kod / Код

Tirante / Tie-rod / Tirant / Gewindedorn / Tirante / Trzpień / Распорка	M 5	71345393
Tirante / Tie-rod / Tirant / Gewindedorn / Tirante / Trzpień / Распорка	M 6	71345394
Tirante / Tie-rod / Tirant / Gewindedorn / Tirante / Trzpień / Распорка	M 8	71345395

**Kit tirante e testina**

**Tie-rod and head kit**

**Kit tirant et tête**

**Kit Gewindedorn und Mundstück**

**Kit tirante y cabeza**

**Zestaw głowica i trzpień**

**Набор распорка и головка**

## KJ28 - KJ29

Codice / Code  
Kode / Código  
Kod / Код

Tirante / Tie-rod / Tirant / Gewindedorn / Tirante / Trzpień / Распорка	M 5	712877
Tirante / Tie-rod / Tirant / Gewindedorn / Tirante / Trzpień / Распорка	M 6	712879
Tirante / Tie-rod / Tirant / Gewindedorn / Tirante / Trzpień / Распорка	M 8	712881
Testina / Head / Tête / Mundstück / Cabeza / Głowica / Головка	M 5	712878
Testina / Head / Tête / Mundstück / Cabeza / Głowica / Головка	M 6	712880
Testina / Head / Tête / Mundstück / Cabeza / Głowica / Головка	M 8	712882



**Tirante e testina per inserti maschio**

**Tie-rod and head for blind rivet bolts**

**Tirant et tête pour goujons à sertir**

**Gewindedorn und Mundstück für**

**Blindnietsschrauben**

**Tirante y cabeza para esparragos remachables**

**Do mocowania nitotrzpieni za pomocą nitownicy ręcznej**

**Набор распорка и головка для вставок вида метчи.**

## KJ 60

Codice / Code  
Kode / Código  
Kod / Код

Tirante / Tie-rod / Tirant / Gewindedorn / Tirante / Trzpień / Распорка	M 5	713161
Tirante / Tie-rod / Tirant / Gewindedorn / Tirante / Trzpień / Распорка	M 6	713440
Tirante / Tie-rod / Tirant / Gewindedorn / Tirante / Trzpień / Распорка	M 8	713442
Testina / Head / Tête / Mundstück / Cabeza / Głowica / Головка	M 5	713162
Testina / Head / Tête / Mundstück / Cabeza / Głowica / Головка	M 6	713439
Testina / Head / Tête / Mundstück / Cabeza / Głowica / Головка	M 8	713441





# FTT-INOX A2 (AISI 304)



## INSERTI FILETTATI IN ACCIAIO INOX (A2) A TESTA CILINDRICA

STAINLESS STEEL (A2) BLIND RIVET NUTS CYLINDRICAL HEAD

INSERTS FILETÉS EN ACIER INOXYDABLE (A2) TÊTE CYLINDRIQUE

EDELSTAHL (A2) BLINDNIETMUTTERN - FLACHKOPF

TUERCAS REMACHABLES EN ACERO INOXIDABLE (A2), CABEZA ANCHA

NITONAKRÊTKI ZE STALI NIERDZEWNEJ (A2) Z PEASKIM KOENIERZEM

ВСТАВКИ С РЕЗЬБОЙ С ЦИЛИНДРИЧЕСКОЙ ГОЛОВКОЙ ИЗ НЕРЖАВЕЮЩЕЙ СТАЛИ (A2)

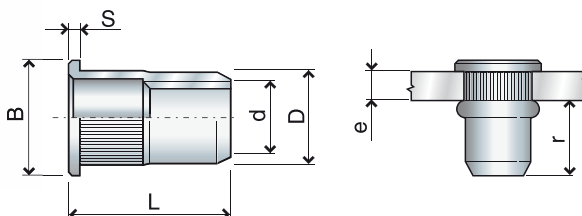

d	Tipo Type / Type Typ / Tipo Typ / Тип	e mm	r max	D	B	S	L	Cod. / Code Kode / Código Kod / Код	€ x 1000	N° Pz. N° pcs / N° pcs Stk Nr. / N° pzs. Ilość szt. Кол-во шт.	Cod. / Code Kode / Código Kod / Код	€ x 1000	N° Pz. N° pcs / N° pcs Stk Nr. / N° pzs. Ilość szt. Кол-во шт.
M3	FTT/C	0,3÷1					8,5	61303102			61303101		
M3	FTT/M *	1÷2	6,7	5	4,9	7	9,5	61303202	117,00	200	61303201	93,50	2.500
M3	FTT/L	2÷3					10,5	61303302			61303301		
M4	FTT/C	0,3÷2,5					11	61304102			61304101		
M4	FTT/L	2,5÷4	7,5	6	5,9	9	13	61304302	177,00	200	61304301	130,00	2.500
M5	FTT/C	0,5÷3					13	61305102			61305101		
M5	FTT/L	3÷5	9,1	7	6,9	10	15,5	61305302	245,00	200	61305301	190,00	2.500
M6	FTT/C	0,5÷3					14,5	61306102			61306101		
M6	FTT/L	3÷5,5	10,2	9	8,9	12	17,5	61306302	431,00	200	61306301	315,00	2.500
M8	FTT/C	0,8÷3,5					17,5	61308102			61308101		
M8	FTT/L	3,5÷6	11,5	11	10,9	15	20	61308302	632,00 705,00	200	61308301	463,00 515,00	2.500
M10	FTT/C	1÷3,5					21	61310102			61310101		
M10	FTT/L	3,5÷6	14,5	13	12,9	17	24	61310302	808,00 922,00	200	61310301	595,00 674,00	2.000

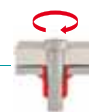

	d	Kg	N	Kgm	Nm
<b>Materiale</b>	M 3 *	387	3.800	0,15	1,5
<i>Material</i>					
<i>Matériel</i>	M 4	632	6.200	0,7	7
<i>Werkstoff</i>					
<i>Material</i>	M 5	1.279	12.550	1,4	14
<i>Material</i>					
<i>Материал</i>	M 6	2.339	22.950	2,2	22
<b>Inox</b>					
<i>Stainless Steel</i>	M 8	3.257	31.950	3,2	32
<i>Acier Inoxydable</i>					
<i>Edelstahl</i>	M 10	4.057	39.800	5,4	54
<i>Acero inoxidable</i>					
<i>Stal inox</i>					
<i>НЕРЖАВЕЮЩАЯ</i>					
<i>Сталь</i>					
<b>AISI 304 Cu</b>					



# FTS-INOX A2 (AISI 304)

## INSERTI FILETTATI IN ACCIAIO INOX (A2) A TESTA SVASATA

STAINLESS STEEL (A2) BLIND RIVET NUTS COUNTERSUNK HEAD

INSERTS FILETÉS EN ACIER INOXYDABLE (A2) TÊTE FRAISÉE

EDELSTAHL (A2) BLINDNIETMUTTERN - SENKKOPF

TUERCAS REMACHABLES EN ACERO INOXIDABLE (A2), CABEZA AVELLANADA

NITONAKRÊTKI ZE STALI NIERDZEWNEJ (A2) Z KOENIERZEM STOŃKOWYM

ВСТАВКИ С РЕЗЬБОЙ С РАСКЛЕШЕННОЙ ГОЛОВКОЙ ИЗ НЕРЖАВЕЮЩЕЙ СТАЛИ (A2)

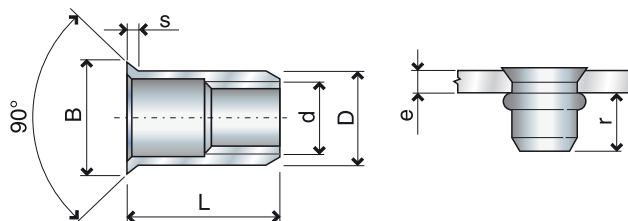

d	Tipo Type / Type Typ / Tipo Typ / Тип	e mm	r max	D	B	S	L	Cod. / Code Kode / Código Kod / Код	€ x 1000	N° Pz. N° pcs / N° pces Stk Nr. / N° pzs. Ilość szt. Кол-во шт.	Cod. / Code Kode / Código Kod / Код	€ x 1000	N° Pz. N° pcs / N° pces Stk Nr. / N° pzs. Ilość szt. Кол-во шт.
M4	FTS/C M4 FTS/L	1,5÷3,5 3,5÷5	7,3	6	5,9	9	1,5 11 13	61404102 61404302	177,00	200	61404101 61404301	130,00	2.500
M5	FTS/C M5 FTS/L	1,5÷3,8 3,8÷6	8,3	7	6,9	10	1,5 13 15	61405102 61405302	245,00	200	61405101 61405301	190,00	2.500
M6	FTS/C M6 FTS/L	1,5÷3,8 3,8÷6	10	9	8,9	12	1,5 15 17	61406102 61406302	431,00	200	61406101 61406301	315,00	2.500
M8	FTS/C M8 FTS/L	1,5÷3,8 3,8÷6	11,2	11	10,9	14	1,5 16,5 19	61408102 61408302	632,00 705,00	200	61408101 61408301	463,00 515,00	2.500
M10	FTS/C M10 FTS/L	1,5÷3,5 3,5÷6	13	13	12,9	16	1,5 18 20,5	61410102 61410302	808,00 922,00	200	61410101 61410301	595,00 674,00	2.000

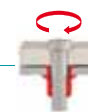

	d	Kg	N	Kgm	Nm
<b>Materiale</b> Material Matériel Werkstoff Material Material Материал	M 4	632	6.200	0,7	7
<b>Inox</b> Stainless Steel Acier Inoxydable Edelstahl Acero inoxidable Stal inox НЕРЖАВЕЮЩАЯ Сталь	M 5	1.279	12.550	1,4	14
	M 6	2.339	22.950	2,2	22
	M 8	3.257	31.950	3,2	32
<b>AISI 304 Cu</b>	M 10	4.057	39.800	5,4	54



# FTR-INOX A2 (AISI 304)

## INSERTI FILETTATI IN ACCIAIO INOX (A2) A TESTA RIDOTTA

STAINLESS STEEL (A2) BLIND RIVET NUTS REDUCED HEAD

INSERTS FILETÉS EN ACIER INOXYDABLE (A2) TÊTE RÉDUITE

EDELSTAHL (A2) BLINDNIETMUTTERN - KLEINKOPF

TUERCAS REMACHABLES EN ACERO INOXIDABLE (A2), CABEZA REDUCIDA

NITONAKRÊTKI ZE STALI NIERDZEWNEJ (A2) Z MINI-KOŁNIERZEM

ВСТАВКИ С РЕЗЬБОЙ С СУЖЕННОЙ ГОЛОВКОЙ ИЗ НЕРЖАВЕЮЩЕЙ СТАЛИ (A2)

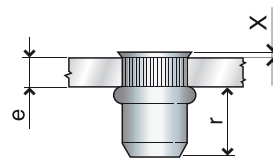
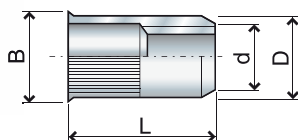

d	Tipo Type / Type Typ / Tipo Typ / Тип	e mm	r max	D	B	X	L	Cod. / Code Kode / Código Kod / Код	€	N° Pz. N° pcs / N° pcs Stk Nr. / N° pcs. Ilość szt. Кол-во шт.	Cod. / Code Kode / Código Kod / Код	€	N° Pz. N° pcs / N° pcs Stk Nr. / N° pcs. Ilość szt. Кол-во шт.	
									x 1000			x 1000		
M3	FTR *	0,5÷1,5	6,5	5	4,9	5,5	0,3	8,5	61503002	90,00	200	61503001	71,00	2.500
M4	FTR	0,5÷1,5	8	6	5,9	6,75	0,4	10	61504002	135,00	200	61504001	107,00	2.500
M5	FTR	0,5÷2	9,6	7	6,9	8	0,4	12	61505002	230,00	200	61505001	180,00	2.500
M6	FTR	0,5÷2	10,7	9	8,9	10	0,5	13,5	61506002	386,00	200	61506001	290,00	2.500
M8	FTR	1÷2,5	12,4	11	10,9	12	0,5	16,5	61508002	545,00	200	61508001	408,00	2.500
M10	FTR	1÷3,5	15,5	13	12,9	14,5	0,8	20	61510002	680,00	200	61510001	510,00	2.000

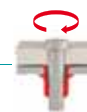

	d	Kg	N	Kgm	Nm
<b>Materiale</b>	M 3 *	387	3.800	0,15	1,5
<b>Material</b>	M 4	632	6.200	0,7	7
<b>Matériel</b>	M 5	1.279	12.550	1,4	14
<b>Werkstoff</b>	M 6	2.339	22.950	2,2	22
<b>Material</b>	M 8	3.257	31.950	3,2	32
<b>Material</b>	M 10	4.057	39.800	5,4	54
<b>Материал</b>					
<b>Inox</b>					
<b>Stainless Steel</b>					
<b>Acier Inoxydable</b>					
<b>Edelstahl</b>					
<b>Acero inoxidable</b>					
<b>Stal inox</b>					
<b>НЕРЖАВЕЮЩАЯ</b>					
<b>Сталь</b>					
<b>AISI 304 Cu</b>					





# PR-INOX A2 (AISI 304)

## INSERTI FILETTATI IN ACCIAIO INOX (A2) A TESTA RIDOTTA

STAINLESS STEEL (A2) BLIND RIVET NUTS REDUCED HEAD

INSERTS FILETÉS EN ACIER INOXYDABLE (A2) TÊTE RÉDUITE

EDELSTAHL (A2) BLINDNIETMUTTERN - KLEINKOPF

TUERCAS REMACHABLES EN ACERO INOXIDABLE (A2), CABEZA REDUCIDA

NITONAKRĘTKI ZE STALI NIERDZEWNEJ (A2) Z MINI-KOENIERZEM

ВСТАВКИ С РЕЗЬБОЙ С СУЖЕННОЙ ГОЛОВКОЙ ИЗ НЕРЖАВЕЮЩЕЙ СТАЛИ (A2)

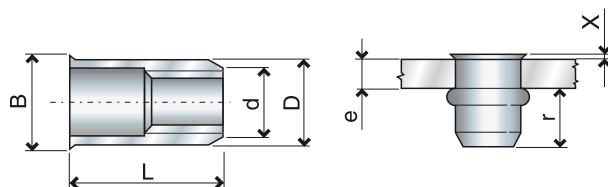

d	Tipo Type / Type Typ / Tipo Typ / Тип	e mm	r max	D	B	X	L	Cod. / Code Kode / Código Kod / Код	€	N° pcs / N° pces Stk Nr. / N° pzs. Ilość szt. Кол-во шт.	Cod. / Code Kode / Código Kod / Код	€	N° pcs / N° pces Stk Nr. / N° pzs. Ilość szt. Кол-во шт.	
									x 1000			x 1000		
M4	PR	0,5÷1,5	7,8	6,4	6,3	6,9	0,4	10,5	62604002	135,00	200	62604001	107,00	2.500
M5	PR	0,5÷2	9	7,2	7,1	7,7	0,4	12	62605002	230,00	200	62605001	180,00	2.500
M6	PR	0,7÷2,5	10,4	9,6	9,5	10,2	0,5	14	62606002	386,00	200	62606001	290,00	2.500
M8	PR	1÷3	11,4	10,6	10,5	11,3	0,5	16	62608002	545,00	200	62608001	408,00	2.500

- > Differiscono dal modello FTR nella dimensione del diametro esterno
- > They differ from the FTR model in the outside diameter dimension
- > Ils diffèrent du modèle FTR par la dimension du diamètre extérieur
- > Sie weichen von dem Typ FTR in der Außendurchmesserabmessung ab
- > Se difieren del modelo FTR en la dimensión del diámetro exterior
- > Nitonakrętki PR różnią się od nitonakrętek FTR średnicą zewnętrzną
- > Отличаются от образца FTR размером внешнего диаметра

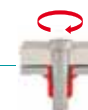

	d	Kg	N	Kgm	Nm
<b>Materiale</b> Material Matériel Werkstoff Material Materiał Материал	M 4	550	5.400	0,7	7
<b>Inox</b> Stainless Steel Acier Inoxydable Edelstahl Acero inoxidable Stal inox НЕРЖАВЕЮЩАЯ Сталь	M 5	1.213	11.900	1,4	14
<b>AISI 304 Cu</b>	M 6	1.662	16.300	2,2	22
	M 8	1.916	18.800	3,2	32



# IE-INOX A2 (AISI 304)



## INSERTI FILETTATI IN ACCIAIO INOX (A2) A TESTA RIDOTTA GAMBO PARZIALMENTE ESAGONALE

STAINLESS STEEL (A2) BLIND RIVET NUTS REDUCED HEAD - HALF HEXAGONAL SHANK

INSERTS FILETÉS EN ACIER INOXYDABLE (A2) TÊTE RÉDUITE QUEUE EN PARTIE HEXAGONALE

EDELSTAHL (A2) BLINDNIETMUTTERN - KLEINKOPF - TEILSECHSKANTSCHAFT

TUERCAS REMACHABLES SEMIHEXAGONALES EN ACERO INOXIDABLE (A2), CABEZA REDUCIDA

NITONAKRÉTKI ZE STALI NIERDZEWNEJ (A2) SZEŚCIOKĄTNE Z MINI-KOENIERZEM

ВСТАВКИ С РЕЗЬБОЙ С СУЖЕННОЙ ГОЛОВКОЙ И НЕПОЛНОСТЬЮ ШЕСТИУГОЛЬНЫМ

СТЕРЖНЕМ ИЗ НЕРЖАВЕЮЩЕЙ СТАЛИ (A2)

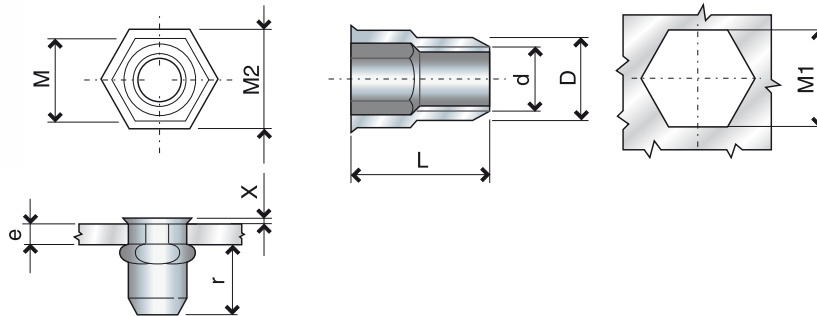

d	Tipo Type / Type Typ / Tipo Typ / Тип	e mm	r max	M1	M	M2	X	D	L	Cod. / Code Kode / Código Kod / Код	€	N° Pz. N° pcs / N° pces Stk Nr. / N° pzs. Ilość szt. Кол-во шт.	Cod. / Code Kode / Código Kod / Код	€	N° Pz. N° pcs / N° pces Stk Nr. / N° pzs. Ilość szt. Кол-во шт.
											x 1000			x 1000	
M4	IE	0,5÷2	8	6	5,9	6,8	0,4	5,9	10,6	61904002	155,00	200	61904001	123,00	2.500
M5	IE	0,5÷3	8	7	6,9	8	0,4	6,9	11,6	61905002	264,00	200	61905001	207,00	2.500
M6	IE	0,5÷3	10,6	9	8,9	10	0,5	8,9	14,5	61906002	444,00	200	61906001	333,00	2.500
M8	IE	0,8÷3	11,1	11	10,9	12	0,5	10,9	15,8	61908002	625,00	200	61908001	470,00	2.500

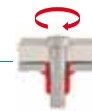
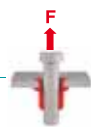

	d	Kg	N	Kgm	Nm
<b>Materiale</b> Material Matériel Werkstoff Material Material Материал	M 4	545	5.350	0,7	7
<b>Inox</b> Stainless Steel Acier Inoxydable Edelstahl Acero inoxidable Stal inox НЕРЖАВЕЮЩАЯ Сталь	M 5	1.182	11.600	1,4	14
	M 6	1.835	18.000	2,2	22
<b>AISI 304 Cu</b>	M 8	2.977	29.200	3,2	32



# IEC-INOX A2 (AISI 304)

## INSERTI FILETTATI IN ACCIAIO INOX (A2) A TESTA RIDOTTA GAMBO PARZIALMENTE ESAGONALE CIECO

STAINLESS STEEL (A2) BLIND RIVET NUTS REDUCED HEAD - HALF HEXAGONAL SHANK - CLOSED END TYPE

INSERTS FILETÉS AVEUGLES EN ACIER INOXYDABLE (A2) TÊTE RÉDUITE QUEUE EN PARTIE HEXAGONALE

EDELSTAHL (A2) BLINDNIETMUTTERN - KLEINKOPF - TEILSECHSKANTSCHAFT GESCHLOSSEN

TUERCAS REMACHABLES SEMIHEXAGONALES CIEGAS EN ACERO INOXIDABLE (A2), CABEZA REDUCIDA

NITONAKRÉTKI ZE STALI NIERDZEWNEJ (A2) SZEŚCIOKĄTNE ZAŚLEPIONE Z MINI-KOŁNIERZEM

ГЛУХИЕ ВСТАВКИ С РЕЗЬБОЙ С СУЖЕННОЙ ГОЛОВКОЙ И НЕПОЛНОСТЬЮ ШЕСТИУГОЛЬНЫМ

СТЕРЖНЕМ ИЗ НЕРЖАВЕЮЩЕЙ СТАЛИ (A2)

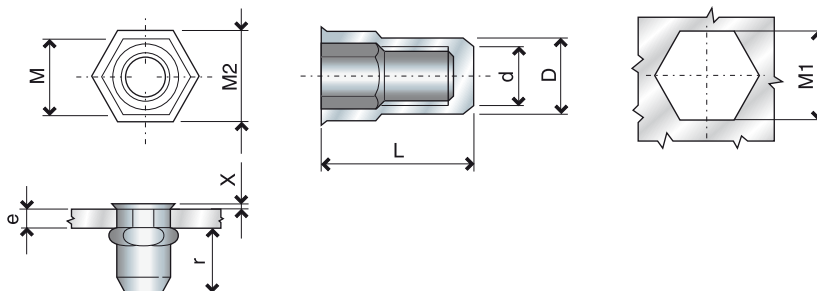

d	Tipo Type / Type Typ / Tipo Typ / Тип	e mm	r max	M1	M	M2	X	D	L	Cod. / Code Kode / Código Kod / Код	€ x 1000	N° Pz. N° pcs / N° pcs Stk Nr. / N° pcs. Ilość szt. Кол-во шт.	Cod. / Code Kode / Código Kod / Код	€ x 1000	N° Pz. N° pcs / N° pcs Stk Nr. / N° pcs. Ilość szt. Кол-во шт.
M5	IEC	0,5÷3	12,6	7	6,9	8	0,4	6,9	16,5	65205002	424,00	200	65205001	315,00	2.500
M6	IEC	0,5÷3	14,7	9	8,9	10	0,5	8,9	19	65206002	716,00	200	65206001	490,00	2.500
M8	IEC	0,8÷3	17,2	11	10,9	12	0,5	10,9	22	65208002	997,50	200	65208001	667,00	2.500

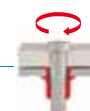

	d	Kg	N	Kgm	Nm
<b>Materiale</b> Material Matériel Werkstoff Material Material Материал	M 5	1.182	11.600	1,4	14
<b>Inox</b> Stainless Steel Acier Inoxydable Edelstahl Acero inoxidable Stal inox НЕРЖАВЕЮЩАЯ Сталь	M 6	1.835	18.000	2,2	22
<b>AISI 304 Cu</b>	M 8	2.977	29.200	3,2	32



# FTTE-INOX A2 (AISI 304)

## INSERTI FILETTATI IN ACCIAIO INOX (A2) A TESTA CILINDRICA GAMBO ESAGONALE

STAINLESS STEEL (A2) BLIND RIVET NUTS CYLINDRICAL HEAD HEXAGONAL SHANK

INSERTS FILETÉS EN ACIER INOXYDABLE (A2) TÊTE CYLINDRIQUE QUEUE HEXAGONALE

EDELSTAHL (A2) BLINDNIETMUTTERN - FLACHKOPF - SECHSKANTSCHAFT

TUERCAS REMACHABLES HEXAGONALES EN ACERO INOXIDABLE (A2), CABEZA ANCHA

NITONAKRÊTKI ZE STALI NIERDZEWNEJ (A2) SZEŚCIOKĄTNE Z PEASKIM KOENIERZEM

ВСТАВКИ С РЕЗЬБОЙ С ЦИЛИНДРИЧЕСКОЙ ГОЛОВКОЙ И ШЕСТИУГОЛЬНЫМ СТЕРЖНЕМ ИЗ НЕРЖАВЕЮЩЕЙ СТАЛИ (A2)

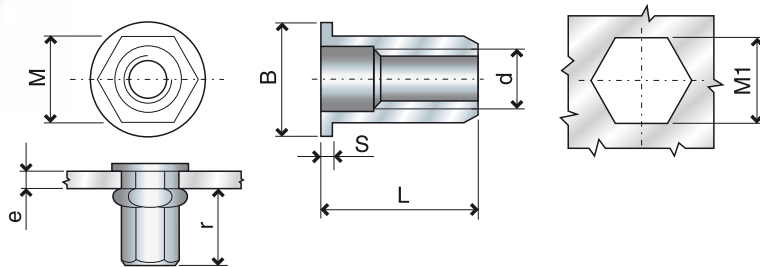

d	Tipo Type / Type Typ / Tipo Typ / Тип	e mm	r max	M1	M	B	S	L	Cod. / Code Kode / Código Kod / Код	€	N° Pz. N° pcs / N° pcs Stk Nr. / N° pcs. Ilość szt. Кол-во шт.	Cod. / Code Kode / Código Kod / Код	€	N° Pz. N° pcs / N° pcs Stk Nr. / N° pcs. Ilość szt. Кол-во шт.
										x 1000			x 1000	
M4	FTTE	0,5÷2	7,1	6	5,9	9	1	11	63004002	193,00	200	63004001	152,00	2.500
M5	FTTE	0,5÷3	9	7	6,9	10	1	14	63005002	280,00	200	63005001	219,00	2.500
M6	FTTE	0,5÷3	10,3	9	8,9	13	1,5	16	63006002	494,00	200	63006001	370,50	2.500
M8	FTTE	0,5÷3	11,8	11	10,9	16	1,5	18	63008002	725,50	200	63008001	574,50	2.500

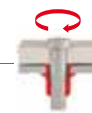

	d	Kg	N	Kgm	Nm
<b>Materiale</b> Material Matériel Werkstoff Material Material Материал	M 4	540	5.300	0,7	7
<b>Inox</b> Stainless Steel Acier Inoxydable Edelstahl Acero inoxidable Stal inox НЕРЖАВЕЮЩАЯ Сталь	M 5	1.233	12.100	1,4	14
	M 6	1.662	16.300	2,2	22
<b>AISI 304 Cu</b>	M 8	3.012	29.550	3,2	32



# FTT-INOX A4 (AISI 316)

## INSERTI FILETTATI IN ACCIAIO INOX (A4) A TESTA CILINDRICA

STAINLESS STEEL (A4) BLIND RIVET NUTS CYLINDRICAL HEAD

INSERTS FILETÉS EN ACIER INOXYDABLE (A4) TÊTE CYLINDRIQUE

EDELSTAHL (A4) BLINDNIETMUTTERN - FLACHKOPF

TUERCAS REMACHABLES EN ACERO INOXIDABLE (A4), CABEZA ANCHA

NITONAKRÊTKI ZE STALI NIERDZEWNEJ (A4) Z PEASKIM KOENIERZEM

ВСТАВКИ С РЕЗЬБОЙ С ЦИЛИНДРИЧЕСКОЙ ГОЛОВКОЙ ИЗ НЕРЖАВЕЮЩЕЙ СТАЛИ (A4)

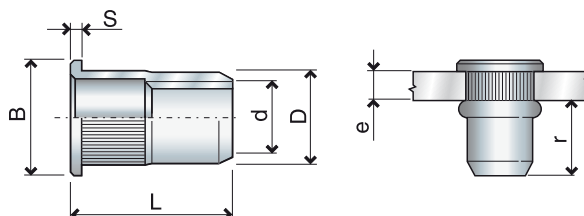

d	Tipo Type / Type Typ / Tipo Typ / Тип	e mm	r max	d	D	B	S	L	Cod. / Code Kode / Código Kod / Код	€ x 1000	N° Pz. N° pcs / N° pcs Stk Nr. / N° pcs. Ilość szt. Кол-во шт.
M5	FTT/C	0,5÷3	9,1	7	6,9	10	1,2	13	64705101	221,00	2.500
M6	FTT/C	0,5÷3	10,2	9	8,9	12	1,5	14,5	64706101	362,50	2.500
M8	FTT/C	0,8÷3,5	11,5	11	10,9	15	1,5	17,5	64708101	532,50	2.500

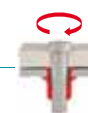

d	Kg	N	Kgm	Nm	
<b>Materiale</b> Material Matériel Werkstoff Material Material Материал	M 5	1.279	12.550	1,4	14
<b>Inox</b> Stainless Steel Acier Inoxydable Edelstahl Acero inoxidable Stal inox НЕРЖАВЕЮЩАЯ Сталь	M 6	2.339	22.950	2,2	22
<b>AISI 316 Cu</b>	M 8	3.257	31.950	3,2	32



# FTR-INOX A4 (AISI 316)

## INSERTI FILETTATI IN ACCIAIO INOX (A4) A TESTA RIDOTTA

STAINLESS STEEL (A4) BLIND RIVET NUTS REDUCED HEAD

INSERTS FILETÉS EN ACIER INOXYDABLE (A4) TÊTE RÉDUITE





EDELSTAHL (A4) BLINDNIETMUTTERN - KLEINKOPF

TUERCAS REMACHABLES EN ACERO INOXIDABLE (A4), CABEZA REDUCIDA

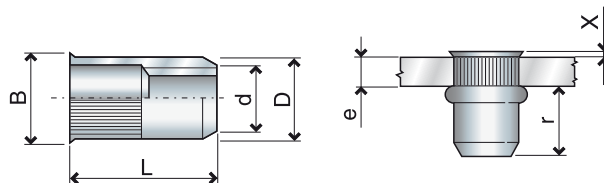
NITONAKRÊTKI ZE STALI NIERDZEWNEJ (A4) Z MINI-KOENIERZEM

ВСТАВКИ С РЕЗЬБОЙ С СУЖЕННОЙ ГОЛОВКОЙ ИЗ НЕРЖАВЕЮЩЕЙ СТАЛИ (A4)



d	Tipo Type / Type Typ / Tipo Typ / Тип	e mm	r max		D	B	X	L	Cod. / Code Kode / Código Kod / Код	 x 1000	N° Pz. N° pcs / N° pcses Stk Nr. / N° pzs. Ilość szt. Кол-во шт.
M5	FTR	0,5÷2	9,6		6,9	8	0,4	12	64805001	207,00	2.500
M6	FTR	0,5÷2	10,7		8,9	10	0,5	13,5	64806001	333,00	2.500
M8	FTR	1÷2,5	12,4		10,9	12	0,5	16,5	64808001	470,00	2.500

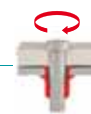

	d	Kg	N	Kgm	Nm
<b>Materiale</b> Material Matériel Werkstoff Material Material Материал	M 5	1.279	12.550	1,4	14
<b>Inox</b> Stainless Steel Acier Inoxydable Edelstahl Acero inoxidable Stal inox НЕРЖАВЕЮЩАЯ Сталь	M 6	2.339	22.950	2,2	22
<b>AISI 316 Cu</b>	M 8	3.257	31.950	3,2	32



## INSERTI FILETTATI IN LEGA DI ALLUMINIO A TESTA CILINDRICA

ALUMINIUM BLIND RIVET NUTS CYLINDRICAL HEAD

INSERTS FILETÉS EN ALUMINIUM TÊTE CYLINDRIQUE

ALU BLINDNIETMUTTERN - FLACHKOPF

TUERCAS REMACHABLES EN ALUMINIO, CABEZA ANCHA

NITONAKRÛTKI ALUMINIOWE Z PEASKIM KOENIERZEM

ВСТАВКИ С РЕЗЬБОЙ С ЦИЛИНДРИЧЕСКОЙ ГОЛОВКОЙ ИЗ АЛЮМИНИЯ

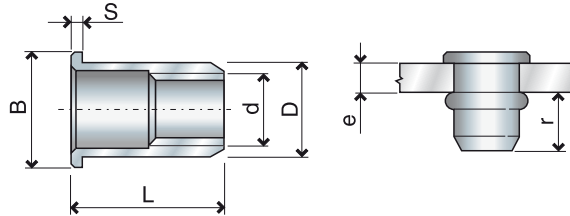

d	Tipo Type / Type Typ / Tipo Typ / Тип	e mm	r max	mm	D	B	S	L	Cod. / Code Kode / Código Kod / Код	€ x 1000	N° Pz. N° pcs / N° pces Stk Nr. / N° pzs. Ilość szt. Кол-во шт.	Cod. / Code Kode / Código Kod / Код	€ x 1000	N° Pz. N° pcs / N° pces Stk Nr. / N° pzs. Ilość szt. Кол-во шт.
M3	FTT/C	0,3÷1,8	6	5	4,9	7	0,8	9	60103102	67,00	200	60103101	50,00	2.500
M4	FTT/C M4 FTT/L	0,3÷2,5 2,5÷4	7,4	6	5,9	9	1	11 13	60104102 60104302	76,00	200	60104101 60104301	54,50	2.500
M5	FTT/C M5 FTT/L	0,5÷3 3÷5	9	7	6,9	10	1,2	13 15,5	60105102 60105302	78,50	200	60105101 60105301	57,50	2.500
M6	FTT/C M6 FTT/M M6 FTT/L	0,5÷2,3 2,3÷4 4÷6	9,7	9	8,9	12	1,5	14,5 16 17,5	60106102 60106202 60106302	103,00	200	60106101 60106201 60106301	74,50	2.500
M8	FTT/C M8 FTT/L	0,8÷3,5 3,5÷6	11,4	11	10,9	15	1,5	17,5 20	60108102 60108302	136,00	200	60108101 60108301	90,50	2.500

Material Matériau Werkstoff Material Material Материал	d	D	Kg	N	Kgm	Nm
Al Mg 3,5	M 3		265	2.600	0,07	0,7
	M 4		398	3.900	0,2	2,5
	M 5		601	5.900	0,5	5
Alluminio Aluminium Aluminium Aluminio Aluminium Алюминий	M 6		877	8.600	0,8	8
	M 8		1.040	10.200	2	20



**INSERTI FILETTATI IN LEGA DI ALLUMINIO A TESTA SVASATA**

ALUMINIUM BLIND RIVET NUTS COUNTERSUNK HEAD

INSERTS FILETÉS EN ALUMINIUM TÊTE FRAISÉE

ALU BLINDNIETMUTTERN - SENKKOPF

TUERCAS REMACHABLES EN ALUMINIO, CABEZA AVELLANADA

NITONAKRÊTKI ALUMINIOWE Z KOENIERZEM STOŃKOWYM

ВСТАВКИ С РЕЗЬБОЙ С РАСКЛЕШЕННОЙ ГОЛОВКОЙ ИЗ АЛЮМИНИЯ

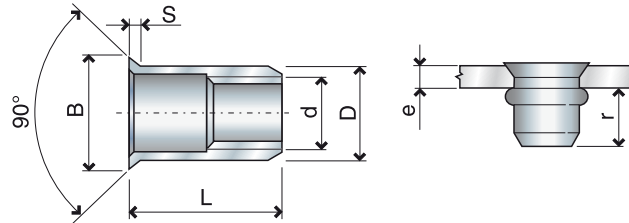

d	Tipo Type / Type Typ / Tipo Typ / Тип	e mm	r max	D	B	S	L	Cod. / Code Kode / Código Kod / Код	€ x 1000	N° Pz. N° pcs / N° pces Stk Nr. / N° pzs. Ilość szt. Кол-во шт.			
										Cod. / Code Kode / Código Kod / Код	€ x 1000	N° Pz. N° pcs / N° pces Stk Nr. / N° pzs. Ilość szt. Кол-во шт.	
M4	FTS/C	1,5÷3,5	7,4	6	5,9	9	1,5	11	76,00	200	60304101	54,50	2.500
	FTS/L	3,5÷5											
M5	FTS/C	1,5÷3,8	8,5	7	6,9	10	1,5	13	78,50	200	60305101	57,50	2.500
	FTS/L	3,8÷6											
M6	FTS/C	1,5÷3,8	10,2	9	8,9	12	1,5	15	103,00	200	60306101	74,50	2.500
	FTS/L	3,8÷6											
M8	FTS/C	1,5÷3,8	11,4	11	10,9	14	1,5	16,5	136,00	200	60308101	90,50	2.500
	FTS/L	3,8÷6											

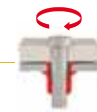

Materiale Material Matériel Werkstoff Material Materiał Материал	d	Kg	N	Kgm	Nm
Aluminio Aluminium Aluminium Aluminium Aluminium Алюминий	M 4	398	3.900	0,2	2,5
	M 5	601	5.900	0,5	5
	M 6	877	8.600	0,8	8
Al Mg 3	M 8	1.040	10.200	2	20





## INSERTI FILETTATI CIECHI IN LEGA DI ALLUMINIO A TESTA CILINDRICA

ALUMINIUM BLIND RIVET NUTS CYLINDRICAL HEAD - CLOSED END TYPE

INSERTS FILETÉS AVEUGLES EN ALUMINIUM TÊTE CYLINDRIQUE

ALU BLINDNIETMUTTERN - FLACHKOPF - RUNDSCHAFT GESCHLOSSEN

TUERCAS REMACHABLES CIEGAS EN ALUMINIO, CABEZA ANCHA

NIŃONAKRĘTKI ALUMINIOWE ZAŚLEPIONE Z PEASKIM KOENIERZEM

ГЛУХИЕ ВСТАВКИ С РЕЗЬБОЙ С ЦИЛИНДРИЧЕСКОЙ ГОЛОВКОЙ ИЗ АЛЮМИНИЯ

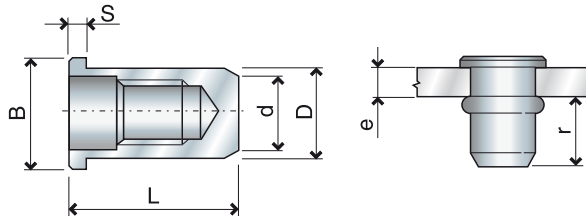

d	Tipo Type / Type Typ / Tipo Typ / Тип	e mm	r max	D	B	S	L	Cod. / Code Kode / Código Kod / Код	€ x 1000	N° Pz. N° pcs / N° pcs Stk Nr. / N° pzs. Ilość szt. Кол-во шт.	Cod. / Code Kode / Código Kod / Код	€ x 1000	N° Pz. N° pcs / N° pcs Stk Nr. / N° pzs. Ilość szt. Кол-во шт.	
M3	FTTC/C	0,3÷1,8	11,2	5	4,9	7	0,8	14,5	60703102	105,00	200	60703101	82,00	2.500
M3	FTTC/L	1,8÷3						15,5	60703302			60703301		
M4	FTTC/C	0,3÷2,5	13	6	5,9	9	1	16,5	60704102	120,00	200	60704101	92,00	2.500
M4	FTTC/L	2,5÷4						18	60704302			60704301		
M5	FTTC/C	0,5÷3	14	7	6,9	10	1,2	18	60705102	138,00	200	60705101	98,00	2.500
M5	FTTC/L	3÷5						20,5	60705302			60705301		
M6	FTTC/C	0,5÷2,3	15,7	9	8,9	12	1,5	20,5	60706102	175,00	200	60706101	130,00	2.500
M6	FTTC/M	2,3÷4						22	60706202			60706201		
M6	FTTC/L	4÷6						23,5	60706302			60706301		
M8	FTTC/C	0,8÷3,5	19,4	11	10,9	15	1,5	25,5	60708102	232,00	200	60708101	154,00	2.000
M8	FTTC/L	3,5÷6						28	60708302			60708301		

Materiale Material Matériel Werkstoff Material Material Материал	d	Kg	N	Kgm	Nm
Al Mg 3,5	M 3	265	2.600	0,07	0,7
	M 4	398	3.900	0,2	2,5
	M 5	601	5.900	0,5	5
Alluminio Aluminium Aluminium Aluminium Aluminio Aluminium Алюминий	M 6	877	8.600	0,8	8
	M 8	1.040	10.200	2	20



## INSERTI FILETTATI SPECIALI

THE SPECIAL BLIND RIVET NUTS

LES INSERTS FILETÉS SPÉCIAUX

DIE SPEZIELLEN BLINDNIETMUTTERN

LAS TUERCAS REMACHABLES ESPECIALES

NITONAKRĘTKI SPECJALNE

СПЕЦИАЛЬНЫЕ ВСТАВКИ С РЕЗЬБОЙ



**> I** Oltre ai modelli di serie descritti nelle pagine precedenti è possibile fornire inserti secondo specifiche del cliente, nelle figure vengono indicati alcuni esempi.

È consigliabile, all'atto della richiesta, unire un disegno tecnico del particolare.

**> GB** In addition to the standard items described in the previous pages, we can also supply blind rivet nuts in accordance with customer requirements and specifications. Above, some examples.

A technical drawing of the special insert is required.

**> F** En dehors des modèles standards indiqués dans les pages précédentes, nous pouvons fabriquer des inserts spéciaux sur demande. Exemple sur les figures ci-dessus.

Nous vous suggérons de joindre un plan pour la réalisation des pièces demandées.

**> D** Neben den in den vorherigen Seiten beschriebenen Serienmodellen, ist es auch möglich, Blindnietmuttern nach den Spezifikationen des Kunden zu liefern. Die Abbildungen oben zeigen einige Beispiele.

Bei der Anfrage wird empfohlen, eine technische Zeichnung des gewünschten Stückes zu senden.

**> E** Además a los modelos de serie descritos en las páginas anteriores, es posible abastecer insertos según las exigencias específicas del cliente; en las figuras mostramos algunos ejemplos.

Es aconsejable al momento del pedido adjuntar un diseño técnico del detalle en cuestión.

**> PL** Oprócz nitonakrętek standardowych, firma FAR może wykonać nitonakrętki specjalne, wg. zamówienia klienta i jego wzoru. Przy składaniu zapytania, prosimy o dołączenie rysunku technicznego.

**> RUS** Кроме серийных образцов, описанных на предыдущих страницах, мы так же можем поставлять вставки изготовленные по специальному требованию наших клиентов, выше указаны некоторые из возможных вариантов. Для спецзаказов требуется технический рисунок востребованной детали.





S.r.l.



SEDE • HEAD OFFICE • SIEGE • HAUPTSITZ • SEDE • SIEDZIBA • ЦЕНТРАЛЬНЫЙ ОФИС:

Via Giovanni XXIII, 2 - Fraz. Quarto Inferiore  
40057 Granarolo Emilia - Bologna - Italy  
Tel. +39 0516009511 - FAX +39 051767443  
Fax EXPORT +39 051768284

DEPOSITO • WAREHOUSE • DEPOT • WARENLAGER • ALMACEN • ODDZIAŁ • СКЛАД:

20099 Sesto San Giovanni - Milano - Italy  
Via Archimede, 8  
Tel. +39 022409634  
FAX +39 0226222279

E-mail: [export@far.bo.it](mailto:export@far.bo.it) - [itacom@far.bo.it](mailto:itacom@far.bo.it)

WEB: [www.far.bo.it](http://www.far.bo.it)

