



Colore / Color / Couleur	
Standard	BLU RAL 5015
A richiesta / On request / Sur commande	GRIGIO RAL 7038

I Banchi da Lavoro sono fra gli articoli storici nella produzione M.G. Da sempre rispondenti alle caratteristiche di robustezza e versatilità, oggi vedono ampliata la gamma della loro offerta con l'introduzione di nuovi modelli, nuovi piani di lavoro ed accessori. I Banchi da lavoro della serie MG sono costruiti con una struttura particolarmente robusta, costituita da scatolari metallici di varie sezioni, di gambe provviste di piastre per il fissaggio a terra, di telaio perimetrale rinforzato posto sotto il piano di lavoro e provvisto di inserti per l'alloggiamento delle cassettiere.

I piani di lavoro sono disponibili in due versioni: **in lamiera** spessore mm 3, **in legno** composto da agglomerato ligneo rivestito e bordato in compensato di faggio, spessore mm 40. **I banchi possono essere accessoriati con kit elettrici, pneumatici e pannelli portattrezzi.** Progettati per valorizzarne la versatilità, sono forniti sia nella versione, **Monoblocco** : banchi con struttura già montata e saldata, **Componibile**: i banchi, forniti in componenti da assemblare mediante bulloni, offrono la stessa robustezza dei banchi monoblocco facilitandone il trasporto e lo stoccaggio.

Workbenches are historical products in M.G. production. Since always they have met the characteristics of sturdiness and versatility, and today their range is widened thanks the introduction of new models, new work tops and optional. M.G. Workbenches have a special sturdy structure, made of metal profile with various sections, legs equipped with ground fastening plates, strengthened outside frame, which is placed under work surface and provided with holes for the housing of chests of drawers. Work tops are available in two versions: metal surfaces 3 mm thick and wood surfaces 40 mm thick. Work tops can be equipped with electric, pneumatic kit and tool-holder panels. Designed for versatility they are produced monobloc and modular. Monobloc version: top with assembled and welded structure. Modular tops: components to assemble by means of bolts. They offer the same sturdiness as the monobloc ones and make the transport and storage easier.



Les établis sont les produits historiques de M.G. Depuis toujours ils sont solides et universels, aujourd'hui la gamme des établis s'est enrichie grâce à des nouveaux modèles, nouveau plateau de travail et nouveaux outillages. Les établis de la série MG ont une structure particulièrement solide, composée par des éléments métalliques de différentes sections, de pieds équipés avec des plaques de fixation à terre, de châssis périmètre renforcé placé sous le plateau de travail et percé pour le logement des caissons-tiroirs. Les plateaux sont en deux versions: En métal – épaisseur 3 mm En bois – aggloméré de bois, revêtement et bordage en contre-plaqué hêtre, épaisseur 40 mm. Les établis peuvent être équipés avec Prêt-à-monter électrique, pneumatique, et panneaux porte outillage. Les établis sont projetés en fonction de leur flexibilité, ils sont produits en version monobloc – établis assemblés et éléments soudés – et à éléments – à monter à moyen de boulons. Les établis à éléments sont ainsi robustes que ceux monoblocs, leur transport et stockage est plus simple.



Cassettiere per banchi da lavoro serie MG

Chests of drawers for workbenches line MG / Caissons-tiroirs pour etablis de travail

Sono predisposte per essere applicate, mediante bulloni, al telaio perimetrale preforato, posto sotto il piano di lavoro. I cassetti scorrono su guide con cuscinetti che garantiscono una portata di 30 kg. ed una ottima scorrevolezza. Ogni cassetto è dotato di serratura. Ad ogni tipo di cassetiera è abbinata una lettera identificativa necessaria nell'indicazione della composizione del banco e nell'identificazione dell'articolo.

They are prepared to be assembled, through bolts, to the pierced perimetral frame, under the work top. The drawers slide on guides with bearings which assure a capacity of 30 kg and the best smoothness. Each drawer has a lock. Any chest of drawers has an identification letter which must be indicated to set up the bench and to identify the article.

Ils sont projetés pour être montés à moyen des boulons sur le châssis périmètre percé sous le plateau de travail. Les tiroirs roulent sur guides avec roulements qui garantissent considérable portée et optimale fluidité. Chaque tiroir a sa serrure. Chaque caissons-tiroirs est associé à une lettre identificatrice nécessaire pour indiquer la composition du établis et pour identifier le produit.

CASSETTIERE					
	ART.		L	P	H
	MG116	Cassettiera ad 1 cassetto. Lettera identificativa "A" <i>Chest of drawers with 1 drawer. Identification letter "A"</i> <i>Caissons-tiroirs avec 1 tiroir. Lettre d'identification « A »</i>	505	580	210
	MG117	Cassettiera a 3 cassetti. Lettera identificativa "B" <i>Chest of drawers with 3 drawers. Identification letter "B"</i> <i>Caissons-tiroirs avec 3 tiroirs. Lettre d'identification « B ».</i>	505	580	600
	MG118	Cassettiera ad 1 cassetto ed 1 vano con anta e pianetto interno rimovibile. Lettera identificativa "C" <i>Chest of drawers with 1 drawer and 1 opening with door and removable inside shelf. Identification letter "C"</i> <i>Caissons-tiroirs avec 1 tiroirs et 1 embrasure avec volet et petite étagère interne amovible. Lettre d'identification « C ».</i>	505	580	600

Esempio di composizione:

In ogni banco si possono inserire varie combinazioni di cassettiere. In fase di ordine, per comporre il codice del prodotto, è sufficiente unire al codice della struttura vuota del banco, le lettere identificative del tipo di cassettiere scelte, come da schema.

Example of assembling: In each bench you can place various chests of drawers. Ordering, to write the product code, you have to add to the empty structure code of the bench the identification letters of the model of the chest of drawers you chose, as indicate in the scheme

Exemple de composition: dans chaque établis on peut monter différentes combinaisons de caissons-tiroirs. Pendant l'ordre, pour composer le code du produit il faut unir au code de la structure vide du établis, les lettres identificatrices du modèle de caissons-tiroirs choisis, comme indiqué dans le schéma.

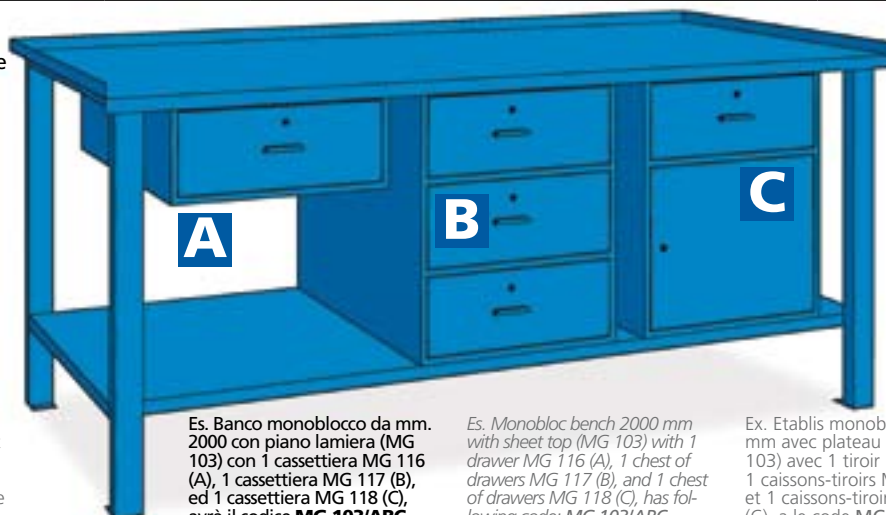

Es. Banco monoblocco da mm. 2000 con piano lamiera (MG 103) con 1 cassetiera MG 116 (A), 1 cassetiera MG 117 (B), ed 1 cassetiera MG 118 (C), avrà il codice **MG 103/ABC**.

Es. Monobloc bench 2000 mm with sheet top (MG 103) with 1 drawer MG 116 (A), 1 chest of drawers MG 117 (B), and 1 chest of drawers MG 118 (C), has following code: **MG 103/ABC**.

Ex. Etablis monobloc de 2000 mm avec plateau en tôle (MG 103) avec 1 tiroir MG 116 (A), 1 caissons-tiroirs MG 117 (B), et 1 caissons-tiroirs MG 118 (C), a le code **MG 103/ABC**.





Accessori per banchi da lavoro serie MG

Optionals for workbenches / Accessoires pour établis

I banchi da lavoro sono predisposti per essere accessoriati con molti componenti. Oltre a vari tipi di pannelli e mobili portattrezzi, indicati nelle altre sezioni del catalogo, indichiamo qui di seguito alcuni accessori da applicare alla struttura ed al cassetto.

The workbenches are prepared to be equipped with many elements. Beside various panels and tool-holder furniture, indicated in this catalogue, here follow some optionals to assemble on the structure and on the drawer.

Les établis sont projetés pour être équipés avec plusieurs accessoires. En outre de différents panneaux et éléments porte outillage indiqués dans les autres sections du catalogue, ci-joint vous pouvez trouver des accessoires à fixer à la structure et au tiroir.

	ART.	Dotazione elettrica	Dotazione pneumatica:	L	P	H
	KEP 01	protezioni: - 2 interruttori magnetotermici tipo C 6KA 2P 16A 230V - 1 interruttore magnetotermico tipo C 6KA 3P 16A 400V prese: - 1 presa 10/16A ita/ed 220V - 1 presa 2P+T 16A 220V - 1 presa 3P+T 16A 380V 2 magneto thermic switches type C 6KA 2P 16A 230V, 1 magneto thermic switch type C6KA3P 16A400V, 1 plug 10/16A it/de 220V, 1 plug 2P+T 16A220V, 1 plug 3P+T16A380V 2 interrupteurs magneto thermiques type C 6KA 2P 6A 230V, 1 interrupteur magneto thermique type C6KA3P 16A400V, 1 prise 10/16A it/al 220V, 1 prise 2P+T 16A 220V, 1 prise 3P+T 16A 380V	- riduttore di pressione con manometro e 2 prese rapide - pressure reducer with gauge and 2 quick plugs - réducteur de pression avec manomètre et 2 prises rapides	110	56	600
	KEP 02	protezioni: - 1 interruttore magnetotermico tipo C 6KA 2P 16A 230V - 1 interruttore magnetotermico tipo C 6KA 3P 16A 400V prese: - 2 prese 2P+T 16A 220V - 1 presa 3P+T 16A 380V 1 magneto thermic switches type C6KA2P16A230V, 1 magneto thermic switch type C6KA3P 16A400V, 2 plugs 2P+T 16A220V, 1 plug 3P+T 16A380V 1 interrupteur magneto thermique type C 6KA 2P 16A 230V, 1 interrupteur magneto thermique type C6KA3P 16A400V, 2 prises 2P+T 16A 220V, 1 prise 3P+T 16A 380V	- riduttore di pressione con manometro e 2 prese rapide - pressure reducer with gauge and 2 quick plugs - réducteur de pression avec manomètre et 2 prises rapides	110	56	600
KEP 03	protezioni: - 2 interruttori magnetotermici tipo C 6KA 2P 16A 230V prese: - 1 presa 10/16A ita/ed 220V - 2 prese 2P+T 16A 220V 2 magneto thermic switches type C6KA2P 16A230V, 1 plug 10/16A it/de 220V, 2 plugs 2P+T 16A220V - 2 interrupteurs magneto thermiques type C 6KA 2P 16A 230V, 1 prise 10/16A it/al 220V, 1 prise 2P+T 16A 220V, 1 prise 3P+T 16A 220V	- riduttore di pressione con manometro e 2 prese rapide - pressure reducer with gauge and 2 quick plugs - réducteur de pression avec manomètre et 2 prises rapides	110	56	600	
	KEP 04	Riduttore di pressione con manometro e 2 prese rapide Pressure reducer with gauge and 2 quick plugs Réducteur de pression avec manomètre et 2 prises rapides		68	43	153
	VAC 01	Vaschetta zincata per cassetto Galvanised tub for drawer Cuve galvanisée pour tiroir		378	150	30
	ART.	Rivestimento in lamiera zincata per piani di lavoro in legno Covered with galvanised sheet for wood work tops Revêtement en tôle galvanisée pour plateau de travail en bois		L	P	
	MG 171			1000	700	
	MG 172			1500	700	
	MG 173			2000	700	
	MG 174			2500	700	

MG 101

Banchi monoblocco con piano in lamiera

Monobloc benches with sheet top / Etablis monobloc avec plateau en tôle

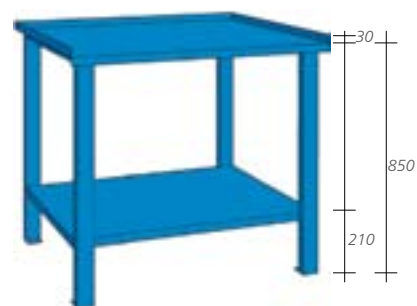

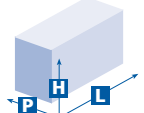
	Dimensioni banco (mm.)		
	L	P	H
	1000	700	850

Portata (kg.)
700

MG 101
Banco senza cassetti



MG 101/A
Banco dotato di 1 cassetiera MG 116



MG 101/B
Banco dotato di 1 cassetiera MG 117



MG 101/C
Banco dotato di 1 cassetiera MG 118

MG 102

Banchi monoblocco con piano in lamiera

Monobloc benches with sheet top / Etablis monobloc avec plateau en tôle

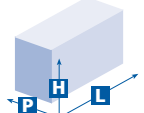

	Dimensioni banco (mm.)		
	L	P	H
	1500	700	850

Portata (kg.)
600



MG 102
Banco senza cassetti



MG 102/A
Banco dotato di 1 cassetiera MG 116



MG 102/B
Banco dotato di 1 cassetiera MG 117



MG 102/C
Banco dotato di 1 cassetiera MG 118



MG 102/AA
Banco dotato di 2 cassetiere MG 116



MG 102/AB
Banco dotato di 1 cassetiera MG 116
ed 1 cassetiera MG 117



MG 102/AC
Banco dotato di 1 cassetiera MG 116
ed 1 cassetiera MG 118



MG 102/BB
Banco dotato di 2 cassetiere MG 117



MG 102/BC
Banco dotato di 1 cassetiera MG 117
ed 1 cassetiera MG 118



MG 102/CC
Banco dotato di 2 cassetiere MG 118

MG 103

Banchi monoblocco con piano in lamiera

Monobloc benches with sheet top / Etablis monobloc avec plateau en tôle

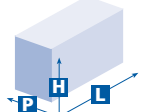

Banchi da lavoro serie MG

	Dimensioni banco (mm.)		
	L	P	H
	2000	700	850

Portata (kg.)
400



MG 103
Banco senza cassetti



MG 103/A
Banco dotato di 1 cassettera MG 116



MG 103/B
Banco dotato di 1 cassettera MG 117



MG 103/C
Banco dotato di 1 cassettera MG 118



MG 103/AA
Banco dotato di 2 cassettere MG 116



MG 103/AB
Banco dotato di 1 cassettera MG 116 ed 1 cassettera MG 117



MG 103/AC
Banco dotato di 1 cassettera MG 116 ed 1 cassettera MG 118



MG 103/BB
Banco dotato di 2 cassettere MG 117



MG 103/BC
Banco dotato di 1 cassettera MG 117 ed 1 cassettera MG 118



MG 103/CC
Banco dotato di 2 cassettere MG 118



MG 103/AAA
Banco dotato di 3 cassettere MG 116



MG 103/ABA
Banco dotato di 2 cassettere MG 116 ed 1 cassettera MG 117

MG 104

Banchi monoblocco con piano in lamiera

Monobloc benches with sheet top / Etablis monobloc avec plateau en tôle

Banchi da lavoro serie MG

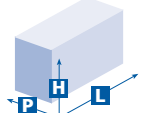

	Dimensioni banco (mm.)		
	L	P	H
	2500	700	850

Portata (kg.)
1300



30
850
210



MG 104

Banco senza cassetti

MG 104/A

Banco dotato di 1 cassetteria MG 116

MG 104/B

Banco dotato di 1 cassetteria MG 117



MG 104/C

Banco dotato di 1 cassetteria MG 118

MG 104/AA

Banco dotato di 2 cassettiere MG 116



MG 104/AB

Banco dotato di 1 cassetteria MG 116 ed 1 cassetteria MG 117

MG 104/AC

Banco dotato di 1 cassetteria MG 116 ed 1 cassetteria MG 118



MG 104/BB

Banco dotato di 2 cassettiere MG 117

MG 104/BC

Banco dotato di 1 cassetteria MG 117 ed 1 cassetteria MG 118

MG 104/CC

Banco dotato di 2 cassettiere MG 118

Banchi monoblocco pannellati

Monobloc benches equipped with panels / Etablis monobloc avec panneaux



MG109

Banco con 2 cassetti e vano con ante. Piano di lavoro in lamiera
 Bench equipped with 2 drawers and opening with doors. Work top made of sheet.
 Etablis avec 2 tiroirs et embrasure avec volet Plateau de travail en tôle.

L 1000 P 700 H 850 portata (kg) 2000



MG112

Banco con 2 cassetti e vano laterale e inferiore chiuso da ante, piano in lamiera
 Bench equipped with 2 drawers and side and lower opening closed with doors, top made of sheet
 Etablis avec 2 tiroirs et embrasure latérale et inférieure fermé par volets, plateau en tôle

L 1000 P 700 H 850 portata (kg) 2000



MG109/L

Banco MG109 con piano di lavoro in legno
 Bench MG109 with work top made of wood
 Etablis MG109 avec plateau de travail en bois

L 1000 P 700 H 890



MG112/L

Banco MG112 con piano di lavoro in legno
 Bench MG112 with work top made of wood
 Etablis MG112 avec plateau de travail en bois

L 1000 P 700 H 890



MG112/D

Banco con 4 cassetti, 2 vani laterali e 2 vani inferiori chiusi da ante, piano in lamiera

Bench equipped with 4 drawers, 2 side openings and 2 lower openings closed with doors, top made of sheet

Etablis avec 4 tiroirs, 2 embrasures latérales et 2 embrasures inférieures fermées par volets. Plateau en tôle

L	2000	P	700	H	850	portata (kg)	1500
---	------	---	-----	---	-----	--------------	------



MG112/DL

Banco MG112/D con piano di lavoro in legno

Bench MG112/D with work top made of wood

Etablis MG112/D avec plateau de travail en bois

L	2000	P	700	H	890
---	------	---	-----	---	-----

MG 105

Banchi monoblocco con piano in legno

Monobloc benches with top made of wood / Etablis monobloc avec plateau en bois



Banchi da lavoro serie MG

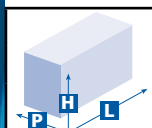

Dimensioni banco (mm.)		
L	P	H
1000	700	890

Portata (kg.)
700

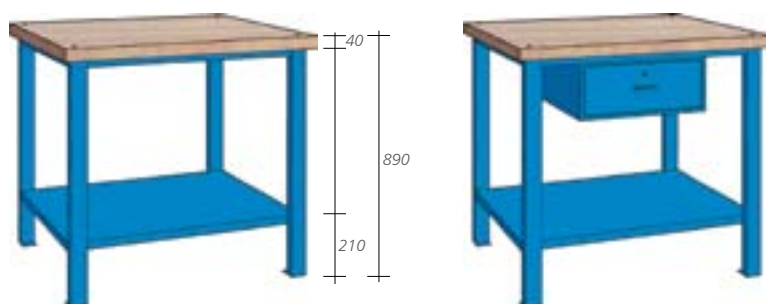

MG 105

Banco senza cassetti

MG 105/A

Banco dotato di 1 cassettera MG 116



MG 105/B

Banco dotato di 1 cassettera MG 117

MG 105/C

Banco dotato di 1 cassettera MG 118



MG 106

Banchi monoblocco con piano in legno

Monobloc benches with top made of wood / Etablis monobloc avec plateau en bois

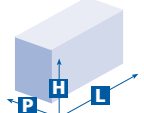

	Dimensioni banco (mm.)		
	L	P	H
	1500	700	890

Portata (kg.)
600



40
890
210



MG 106

Banco senza cassetti

MG 106/A

Banco dotato di 1 cassettera MG 116

MG 106/B

Banco dotato di 1 cassettera MG 117



MG 106/C

Banco dotato di 1 cassettera MG 118

MG 106/AA

Banco dotato di 2 cassette MG 116

MG 106/AB

Banco dotato di 1 cassettera MG 116 ed 1 cassettera MG 117



MG 106/AC

Banco dotato di 1 cassettera MG 116 ed 1 cassettera MG 118

MG 106/BB

Banco dotato di 2 cassette MG 117

MG 106/BC

Banco dotato di 1 cassettera MG 117 ed 1 cassettera MG 118



MG 106/CC

Banco dotato di 2 cassette MG 118

MG 107

Banchi monoblocco con piano in legno

Monobloc benches with top made of wood / Etablis monobloc avec plateau en bois

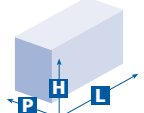

	Dimensioni banco (mm.)		
	L	P	H
	2000	700	890

Portata (kg.)
400



MG 107
Banco senza cassetti



MG 107/A
Banco dotato di 1 cassetteria MG 116



MG 107/B
Banco dotato di 1 cassetteria MG 117



MG 107/C
Banco dotato di 1 cassetteria MG 118



MG 107/AA
Banco dotato di 2 cassettiere MG 116



MG 107/AB
Banco dotato di 1 cassetteria MG 116 ed 1 cassetteria MG 117



MG 107/AC
Banco dotato di 1 cassetteria MG 116 ed 1 cassetteria MG 118



MG 107/BB
Banco dotato di 2 cassettiere MG 117



MG 107/BC
Banco dotato di 1 cassetteria MG 117 ed 1 cassetteria MG 118



MG 107/CC
Banco dotato di 2 cassettiere MG 118



MG 107/AAA
Banco dotato di 3 cassettiere MG 116



MG 107/ABA
Banco dotato di 2 cassettiere MG 116 ed 1 cassetteria MG 117

MG 108

Banchi monoblocco con piano in legno

Monobloc benches with top made of wood / Etablis monobloc avec plateau en bois

Banchi da lavoro serie MG

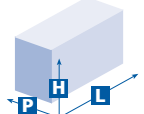

	Dimensioni banco (mm.)		
	L	P	H
	2500	700	890

Portata (kg.)

1300



MG 108
Banco senza cassetti



MG 108/A
Banco dotato di 1 cassetteria MG 116



MG 108/B
Banco dotato di 1 cassetteria MG 117



MG 108/C
Banco dotato di 1 cassetteria MG 118



MG 108/AA
Banco dotato di 2 cassettiere MG 116



MG 108/AB
Banco dotato di 1 cassetteria MG 116 ed 1 cassetteria MG 117



MG 108/AC
Banco dotato di 1 cassetteria MG 116 ed 1 cassetteria MG 118



MG 108/BB
Banco dotato di 2 cassettiere MG 117



MG 108/BC
Banco dotato di 1 cassetteria MG 117 ed 1 cassetteria MG 118



MG 108/CC
Banco dotato di 2 cassettiere MG 118

Banchi su ruote con piano in legno

Benches on wheels with top made of wood / Etablis sur roues avec plateau en bois

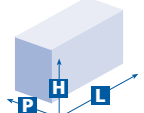

Banchi da lavoro serie MG

	Dimensioni banco (mm.)		
	L	P	H
	1000	700	910

Portata (kg.)	Ruote
250	150 Ø



MG 141

Banco con 2 ruote fisse ø 150 mm



MG 141/A

Banco con 2 ruote fisse ø 150 mm , dotato di 1 cassetteria MG 116



MG 142

Banco con ruote ø 150 mm , (2 fisse e 2 girevoli con freno)



MG 142/A

Banco con ruote ø 150 mm, (2 fisse e 2 girevoli con freno) dotato di 1 cassetteria MG 116



MG 142/B

Banco con ruote ø 150 mm, (2 fisse e 2 girevoli con freno) dotato di 1 cassetteria MG 117



MG 142/C

Banco con ruote ø 150 mm, (2 fisse e 2 girevoli con freno) dotato di 1 cassetteria MG 118



Banchi da lavoro componibili serie MG

Modular workbenches model MG / Etablis à éléments série MG

La serie MG dei banchi da lavoro è disponibile anche nella **versione componibile**. Una versione realizzata per facilitare il trasporto e lo stoccaggio dei banchi, mantenendone inalterata la solidità. La struttura è realizzata in acciaio scatoletto. L'assemblaggio dei componenti, di estrema semplicità, avviene mediante bulloni. **I banchi componibili sono predisposti per l'inserimento degli stessi piani di lavoro, cassettiere ed accessori della versione monoblocco.**

Workbenches MG production is also available in modular version. This version is designed to make the transport and storage of the benches easier, and to keep unchanged their sturdiness. The structure is made of steel. The assembling of the units, very easy, is carried out by means of bolts. Modular benches are prepared for the assembling of the same work tops, chests of drawers and optional in monobloc version.

La série MG des établis est disponible aussi dans la version à éléments. Une version réalisée pour faciliter le transport et le stockage des établis en gardant inchangée leur solidité. La structure est réalisée en acier. Le montage des éléments, très simple, est effectué par des boulons. Les établis à éléments sont préparés pour le montage des mêmes plans de travail, chiffonniers et accessoires de la version monobloc.

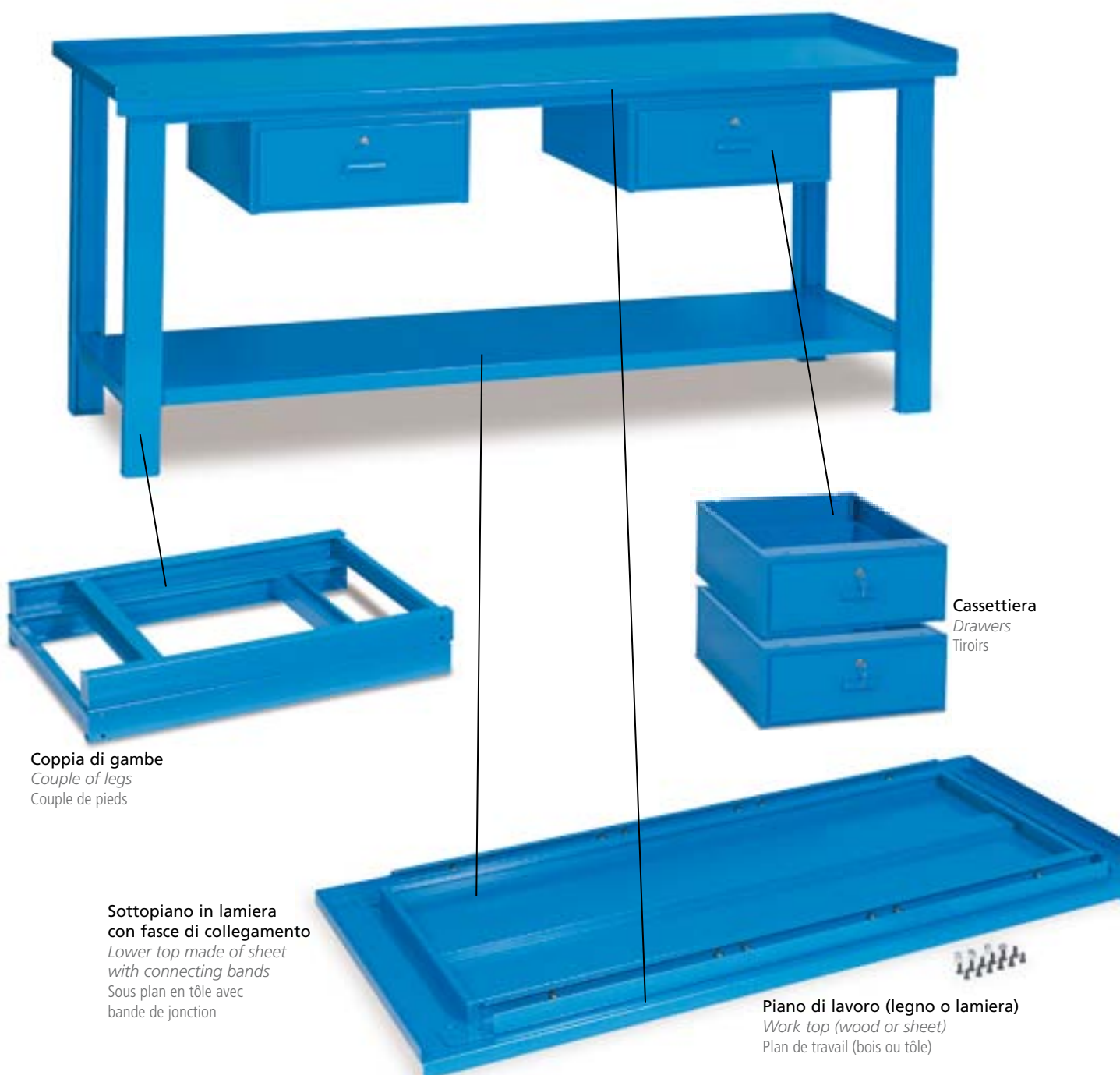

Esempio di composizione:

Per comporre il codice dei banchi da lavoro componibili si ripete la stessa procedura utilizzata nei banchi monoblocco aggiungendo la lettera "S" al codice articolo.

Example of assembling:

To indicate the code of modular workbenches you have to follow the same procedure used for monobloc benches and add an "S" to the code of the product.

Exemple de composition :

Pour composer le code des établis à éléments il faut répéter la même procédure des établis monobloc, en ajoutant la lettre « S » au code du produit.

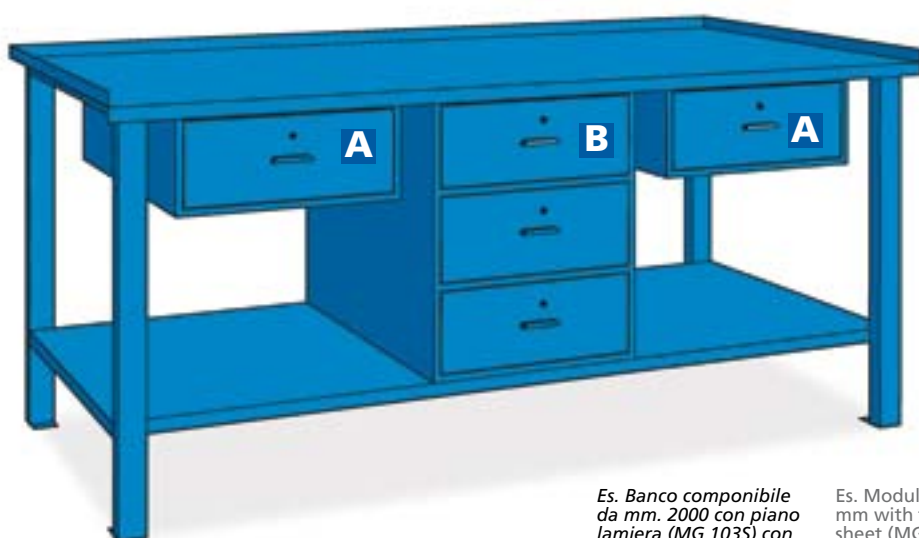

*Es. Banco componibile da mm. 2000 con piano lamiera (MG 103S) con 2 cassettiere MG 116 (A) ed 1 cassettiera MG 117 (B) avrà il codice **MG103S/ABA**.*

*Es. Modular bench 2000 mm with top made of sheet (MG 103S) with 2 drawers MG 116 (A) and 1 drawer MG 117 (B) has the code **MG 103S/ABA**.*

*Ex. Etablis à éléments de 2000 mm avec plan en tôle (MG 103S) avec 2 tiroirs MG 116 (A) et 1 tiroir MG 117 (B) a le code **MG 103S/ABA**.*

MG 101S

Banchi componibili con piano in lamiera

Modular benches with top made of sheet / Etablis à élément avec plateau en tôle



Banchi da lavoro componibili serie MG

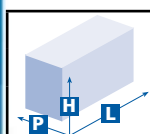
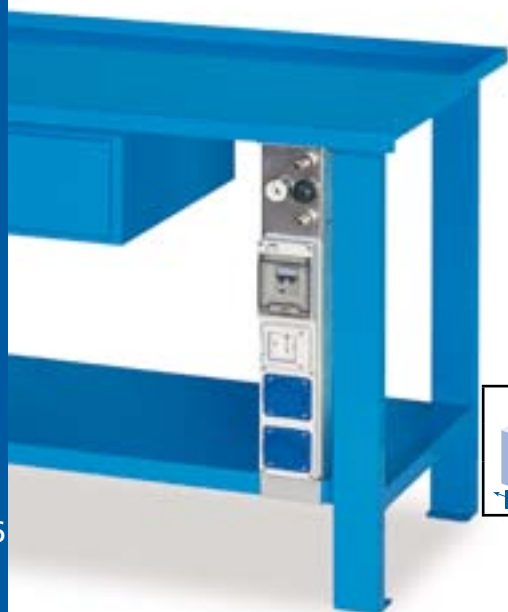

Dimensioni banco (mm.)		
L	P	H
1000	700	850

Portata (kg.)
700

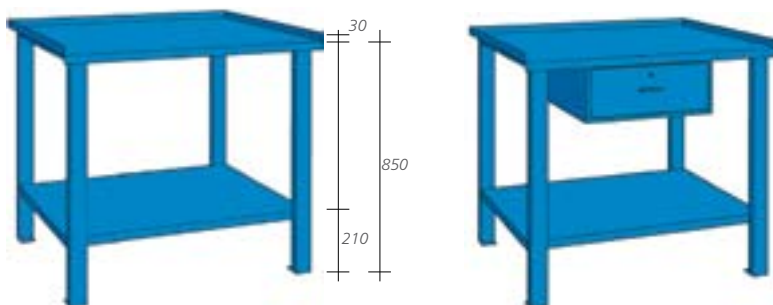

MG 101S
Banco senza cassetti

MG 101S/A
Banco dotato di 1 cassettera MG 116



MG 101S/B
Banco dotato di 1 cassettera MG 117

MG 101S/C
Banco dotato di 1 cassettera MG 118



MG 102S

Banchi componibili con piano in lamiera

Modular benches with top made of sheet / Etablis à élément avec plateau en tôle

Banchi da lavoro componibili serie MG

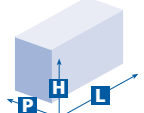

	Dimensioni banco (mm.)		
	L	P	H
	1500	700	850

Portata (kg.)
600



MG 102S
Banco senza cassetti



MG 102S/A
Banco dotato di 1 cassetteria MG 116



MG 102S/B
Banco dotato di 1 cassetteria MG 117



MG 102S/C
Banco dotato di 1 cassetteria MG 118



MG 102S/AA
Banco dotato di 2 cassettiere MG 116



MG 102S/AB
Banco dotato di 1 cassetteria MG 116
ed 1 cassetteria MG 117



MG 102S/AC
Banco dotato di 1 cassetteria MG 116
ed 1 cassetteria MG 118



MG 102S/BB
Banco dotato di 2 cassettiere MG 117



MG 102S/BC
Banco dotato di 1 cassetteria MG 117
ed 1 cassetteria MG 118



MG 102S/CC
Banco dotato di 2 cassettiere MG 118

MG 103S

Banchi componibili con piano in lamiera

Modular benches with top made of sheet / Etablis à élément avec plateau en tôle

Banchi da lavoro componibili serie MG

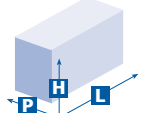

	Dimensioni banco (mm.)		
	L	P	H
	2000	700	850

Portata (kg.)
400



MG 103S
Banco senza cassetti

MG 103S/A
Banco dotato di 1 cassetteria MG 116

MG 103S/B
Banco dotato di 1 cassetteria MG 117



MG 103S/C
Banco dotato di 1 cassetteria MG 118

MG 103S/AA
Banco dotato di 2 cassettiere MG 116

MG 103S/AB
Banco dotato di 1 cassetteria MG 116
ed 1 cassetteria MG 117



MG 103S/AC
Banco dotato di 1 cassetteria MG 116
ed 1 cassetteria MG 118

MG 103S/BB
Banco dotato di 2 cassettiere MG 117

MG 103S/BC
Banco dotato di 1 cassetteria MG 117
ed 1 cassetteria MG 118



MG 103S/CC
Banco dotato di 2 cassettiere MG 118

MG 103S/AAA
Banco dotato di 3 cassettiere MG 116

MG 103S/ABA
Banco dotato di 2 cassettiere MG 116
ed 1 cassetteria MG 117

MG 105S

Banchi componibili con piano in legno

Modular benches with top made of wood / Etablis à élément avec plateau en bois

Banchi da lavoro componibili serie MG

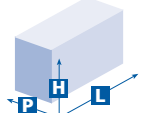

	Dimensioni banco (mm.)		
	L	P	H
	1000	700	890

Portata (kg.)
700

MG 105S
Banco senza cassetti



MG 105S/A
Banco dotato di 1 cassettera MG 116



MG 105S/B
Banco dotato di 1 cassettera MG 117



MG 105S/C
Banco dotato di 1 cassettera MG 118

MG 106S

Banchi componibili con piano in legno

Modular benches with top made of wood / Etablis à élément avec plateau en bois

Banchi da lavoro componibili serie MG

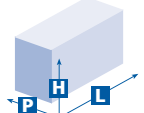

	Dimensioni banco (mm.)		
	L	P	H
	1500	700	890

Portata (kg.)
600



MG 106S

Banco senza cassetti



MG 106S/A

Banco dotato di 1 cassetteria MG 116



MG 106S/B

Banco dotato di 1 cassetteria MG 117



MG 106S/C

Banco dotato di 1 cassetteria MG 118



MG 106S/AA

Banco dotato di 2 cassette MG 116



MG 106S/AB

Banco dotato di 1 cassetteria MG 116 ed 1 cassetteria MG 117



MG 106S/AC

Banco dotato di 1 cassetteria MG 116 ed 1 cassetteria MG 118



MG 106S/BB

Banco dotato di 2 cassette MG 117



MG 106S/BC

Banco dotato di 1 cassetteria MG 117 ed 1 cassetteria MG 118



MG 106S/CC

Banco dotato di 2 cassette MG 118

MG 107S

Banchi componibili con piano in legno

Modular benches with top made of wood / Etablis à élément avec plateau en bois

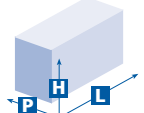

Banchi da lavoro componibili serie MG

	Dimensioni banco (mm.)		
	L	P	H
	2000	700	890

Portata (kg.)
400



MG 107S

Banco senza cassetti



MG 107S/A

Banco dotato di 1 cassettiera MG 116



MG 107S/B

Banco dotato di 1 cassettiera MG 117



MG 107S/C

Banco dotato di 1 cassettiera MG 118



MG 107S/AA

Banco dotato di 2 cassettiere MG 116



MG 107S/AB

Banco dotato di 1 cassettiera MG 116 ed 1 cassettiera MG 117



MG 107S/AC

Banco dotato di 1 cassettiera MG 116 ed 1 cassettiera MG 118



MG 107S/BB

Banco dotato di 2 cassettiere MG 117



MG 107S/BC

Banco dotato di 1 cassettiera MG 117 ed 1 cassettiera MG 118



MG 107S/CC

Banco dotato di 2 cassettiere MG 118



MG 107S/AAA

Banco dotato di 3 cassettiere MG 116



MG 107S/ABA

Banco dotato di 2 cassettiere MG 116 ed 1 cassettiera MG 117